

Colt Manual No. CM102

M16A1 RIFLE

**ARMORER/DEPOT
MAINTENANCE AND REPAIR MANUAL**

REVISED JANUARY 1980



WARNINGS

WARNING: IF THIS FIREARM IS CARELESSLY OR IMPROPERLY HANDLED, UNINTENTIONAL DISCHARGE COULD RESULT AND COULD CAUSE INJURY, DEATH, OR DAMAGE TO PROPERTY.

WARNING: IF THE BARREL IS VERY HOT FROM FIRING THERE IS A RISK OF COOK-OFF (I.e., A ROUND IN THE CHAMBER DISCHARGING BY ABSORBING HEAT FROM THE BARREL). A COOK-OFF CAN OCCUR ANY TIME AFTER CHAMBERING A ROUND IN A VERY HOT BARREL. WHEN THIS CONDITION IS SUSPECTED THE CHAMBER MUST BE CLEARED IMMEDIATELY AFTER FIRING.

WARNING: DO NOT ATTEMPT TO FIRE IF WATER IS IN THE BARREL FROM FORDING, HEAVY RAIN OR THICK FOG. OPEN THE BOLT AND ALLOW WATER TO DRAIN BEFORE FIRING. CLEAN A WET RIFLE AS SOON AS POSSIBLE.

FIVE BASIC SAFETY RULES

1. ALWAYS POINT A GUN IN A SAFE DIRECTION.
2. KEEP FIRE CONTROL SELECTOR ON SAFE UNTIL READY TO FIRE.
3. UNLOAD WHEN NOT IN USE.
4. ALWAYS ENSURE A GUN IS NOT LOADED BEFORE CLEANING OR DISMANTLING.
5. PRACTICE HANDLING AN EMPTY GUN BEFORE ATTEMPTING TO FIRE.

CAUTIONS FOR FIRING

1. WEAR EAR PROTECTION WHEN SHOOTING ON A RANGE TO REDUCE THE RISK OF CUMULATIVE LONG TERM PERMANENT HEARING LOSS.
2. BE SURE OF YOUR TARGET AND THE AREA BEHIND IT. WITHOUT AN ADEQUATE BACKSTOP, BULLETS MAY TRAVEL UP TO 3 MILES PAST OR THROUGH YOUR TARGET.
3. TAKE PRECAUTIONS TO AVOID CONTAMINATION BY ACCUMULATIONS OF TOXIC GAS FUMES OR LEAD DUST WHERE FIREARMS ARE USED INDOORS OR WITHIN A CONFINED SPACE.

CAUTIONS FOR MAINTENANCE

1. ENSURE THAT MAGAZINE IS REMOVED AND THE RIFLE IS NOT LOADED BEFORE STRIPPING, CLEANING OR INSPECTING SO THAT IT WILL NOT FIRE.
2. WEAR SAFETY GLASSES IN CASE YOU LOSE CONTROL OF SOME SPRING LOADED COMPONENT WHICH COULD INJURE YOUR EYES.
3. DO NOT PERMIT LIVE AMMUNITION IN OR NEAR THE WORK AREA.
4. TAKE PRECAUTIONS WHEN HANDLING CLEANING FLUIDS AND LUBRICANTS. IF IN DOUBT SEEK ADVICE FROM THE MANUFACTURERS OF THESE PRODUCTS.

TABLE OF CONTENTS

Section No.	Title	Page No.
	CHAPTER I—INTRODUCTION	
1	General	1
2	Description and Data	2
	CHAPTER II—REPAIR AND MAINTENANCE INSTRUCTIONS	
1	Repair Parts, Special Tools and Equipment	3
2	Troubleshooting	6
3	Maintenance Inspections	7
	CHAPTER III—REPAIR INSTRUCTIONS	18
	CHAPTER IV—MATERIAL USED IN CONNECTION WITH MAJOR ITEM	32
	CHAPTER V—FINAL INSPECTION	34
	CHAPTER VI—REPAIR, REFINISHING AND REASSEMBLY	35
	Torque Requirements	
	*Barrel Nut (30 ft-lb) (4.15 kg m)	38
	*Flash Suppressor (25-30 ft-lb) (3.64-4.15 kg m)	39
	**Carrier Key Screw (35-40 in-lb) (0.40-0.46 kg m)	39
	*Receiver Extension (35-39 ft lb) (4.84-5.39 kg m)	43
	APPENDIX A—ARMORER'S TOOLS (See Page 3 For Tool List)	44
	APPENDIX B—REPLACEMENT PARTS LIST	50
	APPENDIX C—COMPLETE NUMERIC PARTS LIST	60

*Use Combination Wrench, 62696, with Torque Wrench, 94162

**Use Wrench, 94158, with Torque Wrench, 94161

LIST OF ILLUSTRATIONS

Figure No.	Title	Page No.
1-1	M16 A1 Rifle (Right View)	1
1-2	M16 A1 Rifle (Left View)	1
2-1	Disassembly of Rear Swivel	16
2-2	Headspace Check	16
2-3	Chamber Inspection	17
2-4	Firing Pin Protrusion Check	17
3-1	Magazine Disassembly	20
3-2	Disassembly of Upper Receiver Group	21
3-3	Disassembly of Lower Receiver Group	28
4-1	Bayonet-Knife Disassembly	33
6-1	Barrel Nut Installation	38
6-2	Bolt Carrier Key Installation	39
6-3	Pivot Pin Detent Installation Procedure	40
6-4	Hammer Spring and Trigger Pin Installation	43
6-5	Receiver Extension and Buttstock Installation	43
A1	Bore and Chamber Cleaning Tools	44
A2	Combination Wrench	45
A3	Reflector Tool	45
A4	Headspace Gage	45
A5	Punch Set for Front Sight Taper Pin Removal and Installation	46
A6	Pivot Pin Detent Installation Tool	46
A7	Firing Pin Protrusion Gage	46
A8	Punch Setter	46
A9	Bolt Catch Pivot Pin Punch	47
A10	Gas Tube Roll Pin Punch	47
A11	Pivot Pin Detent Depressor	47
A12	Front Sight Post Tools	48
A13	Barrel Removal Vise Jaws	49
B1	Upper Receiver Group	52
B2	Bolt Carrier Group	54
B3	Lower Receiver Group	56
B4	Sling Silent and Magazine	58
B5	Rifle—Exploded View	59
C1	Armorer's Kit	65

LIST OF TABLES

Table No.	Title	Page No.
2-1	Armorer's Kit	3
2-2	Consumable Supplies Requirement	5
2-3	Maintenance Inspections	9
3-1	Guide to Maintenance Functions	19
3-2	Cleaning and Lubrication	29
3-3	Installing a Replacement Barrel and Front Sight Assembly	31

ASSOCIATED MANUAL

The scope of this manual, CM102 is outlined on page 1. For unit maintenance and operator's information and instructions on the 5.56 mm M16A1 Rifle, refer to Colt Manual CM101.

CHAPTER I—INTRODUCTION

SECTION 1—GENERAL

1-1. Scope

This manual provides specific instructions for the inspection and maintenance of the 5.56mm Rifle, M16A1; Bipod, U.S. Model M3; bayonet knife, M7; and scabbard, M8A1 by armorer and depot shop personnel. The information and instructions provided are normally beyond the scope of tools and equipment available to the operator and/or his operational unit.



FIGURE 1-1. M16A1 RIFLE (RIGHT VIEW)



FIGURE 1-2. M16A1 RIFLE (LEFT VIEW)

1-2. Recommendations for Improvement of this Manual

User reports of errors or omissions and recommendations for improving this manual are encouraged. It is requested that such reports be submitted to:

Colt Industries
Firearms Division
150 Huyshope Avenue
Hartford, Connecticut 06102
U.S.A.

SECTION 2—DESCRIPTION AND DATA

1-3. General

Refer to Colt Manual No. CM101, Chapter I, Section 2, page 2, for a description of the rifle and additional information.

CHAPTER II—REPAIR AND MAINTENANCE INSTRUCTIONS

SECTION 1—REPAIR PARTS, SPECIAL TOOLS, AND EQUIPMENT

2-1. Repair Parts

2-1.1 Repair parts for operator and unit maintenance are listed in Colt Manual No. CM101, Appendix B, page 64.

2-1.1 Repair parts for armorer and depot maintenance are listed and illustrated in Appendix B, page 50 of this manual.

2-2. Special Tools and Equipment

The special tools and equipment required for the maintenance and repair operations described in this manual are listed in Tables 2-1 and 2-2, which follow, and in Appendix A, page 44 of this manual.

TABLE 2-1, ARMORER'S KIT, M16 & M16A1 RIFLE

Tool	Colt Part No.	Figure No.	Page No.
Armorer's Kit, M16 & M16A1 Rifle	62675	C1	65
Tool Box, Steel	91414	C1	65
Brush, Bore Cleaning	94144	A1	44
Brush, Chamber Cleaning	94145	A1	44
Punch, Center	94146	6-2B	39
Depressor, Front Sight Detent	62672	A12	48
Depressor, Pivot Pin Detent	62673	A11	47
Gage, Firing Pin Protrusion	62679	A7	46
Gage, Headspace	T27921	A4	45
Wrench Handle, Flexible	94147	3-2C	21
		3-2P	22
		3-2Q	23
Hammer, Ball Peen 8 oz.	94148	—	—
Hammer, Ball Peen 16 oz.	94149	—	—
Hammer, Soft Face	94150	—	—
Pliers, External Retaining Ring	94151	3-2s	23
Punch, Drive Pin— $1/16$ "	94152	3-2a	21

TABLE 2-1, ARMORER'S KIT, M16 & M16A1 RIFLE (Cont.)

Tool	Colt Part No.	Figure No.	Page No.
Punch, Drive Pin (Gas Tube)	62697	A10	47
Punch, Drive Pin— $3/32$ "	94154	A5	46
Punch, Drive Pin— $1/8$ "	94155	3-2K	22
Punch, Drive Pin— $1/4$ "	94156	Para. 6-2	37
Punch, Bolt Catch Pivot Pin	62680	A9	47
Punch, Taper Pin Starter	62682	A5	46
Punch, Taper Pin Insertion	62683	A5	46
Rod, Cleaning, 5.56 mm	62702	A1	44
Screwdriver, Flat Blade Mechanics	94157	3-2Z	24
Screwdriver, Flat Blade Mechanics	94157	4-1A	33
Setter, Punch—180 ID x $3\frac{1}{2}$ " long	62688	—	—
Setter, Punch—190 ID x $3\frac{1}{2}$ " long	62689	—	—
Setter, Punch—190 ID x 6" long	62690	—	—
Setter, Punch—220 ID x $3\frac{1}{2}$ " long	62691	—	—
Setter, Punch—(with flat)	62692	A8	46
Socket, Hex-bit Wrench (with short bit)	94158	6-3A	39
Tool, Alignment, Barrel Nut	62693	6-1B	38
Tool, Pivot Pin Detent Installation	62696	A6	46
Tool, Reflector, Chamber	62694	2-3 & A3	17 & 45
Tool, Swaging, Rivet	62715	C1	5
Vise Jaws, Barrel Removal	62695	A13	49
Vise, Bench, Machinists 4" (Optional)	94154	—	—
Wrench, Combination	62696	A2	45
Wrench, Front Sight Post	62699	A12	48
Wrench, Socket Head Hex Screw	94160	6-2A	39
Wrench, Torque Limiting, $3/8$ " Square Drive	94161	6-2A	39
Wrench, Torque Limiting, $1/2$ " Square Drive	94162	6-2B	38

TABLE 2-2, CONSUMABLE SUPPLIES REQUIREMENT

Item No.	Nomenclature	Quantity
1	Cleaner, Tobacco Pipe	AR
2	Cleaning Compound, Rifle Bore (U.S. Federal Specification, P-C-111 or equivalent)	AR
3	Cleaning Compound, Solvent (U.S. Specification MIL-C-372 or equivalent)	AR
4	Cloth, Abrasive: Crocus Ferric Oxide and Quartz	AR
5	Grease, Molybdenum Disulfide (U.S. Specification MIL-G-21164 or equivalent)	AR
6	Lacquer: Black (jet) Lusterless Acrylic Nitro-Cellulose type (touch up) (U.S. Federal Specification TT-L-50D, Type 1 or U.S. Specification MIL-L 19538; Color 37038)	AR
7	Lubricating Oil, Semi-Fluid (LSA), (U.S. Specification MIL-L-46000)	AR
8	Lubricating Oil, Automatic Weapons (LAW) (U.S. Specification MIL-L-14107)	AR
9	Lubricating Oil, General Purpose Preservative (U.S. Federal Specification VV-L-800 or equivalent)	AR
10	Penetrating Oil (U.S. Federal Specification VV-P-216 or equivalent)	AR
11	Rag, Wiping: Cotton	AR
12	Sealing Compound, "Permatex No. 3D Aviation Form-A-Gasket" (Permatex Co., Brooklyn, N.Y.)	AR
13	Swab, Small Arms Cleaning	AR

AR = As Required

Note: The weapon is compatible with and will function properly using any good grade of oil and bore cleaner. The above formulations are recommended only because it is believed they are the best for all firearms, but equivalent materials would be acceptable.

SECTION 2—TROUBLESHOOTING**2-3. General**

Troubleshooting instructions are contained in Colt Manual No. CM101 Chapter III, Section 5, page 52.

SECTION 3—MAINTENANCE INSPECTIONS**2-4. General**

This section provides specific instructions for inspection of material in the field or in maintenance shops. Troubleshooting information is incorporated wherever applicable as a normal phase of inspection.

2-5. Purpose of Inspection

Inspections are made for the purpose of: (1) determining the condition of an item as to its serviceability; (2) recognizing conditions that would cause failure; (3) assuring proper application of maintenance policies at prescribed levels; and (4) determining the ability of a unit to accomplish its maintenance and supply missions.

2-6. Categories of Inspection

The categories of inspection performed by direct and general support maintenance personnel are listed in paragraphs 2-7 and 2-8 following. For inspection procedures, refer to Table 2-3, page 9.

2-7. Inspection of Material in the Field

This is the inspection of equipment to detect probable failure before unavailability occurs; inspection to determine the availability and use of technical and supply manuals and lubrication instructions; inspection to determine the accuracy of records, authorized levels of equipment and supplies, practice of supply economy, preservation, and knowledge of the proper procedures for requisitioning supplies and equipment, and follow-up thereon.

2-8. Direct and General Support Inspection

2-8.1 Initial Inspection. This is an inspection of material received in maintenance shops for purposes of determining the degree of repairs and parts requirements. This includes determination of modification work orders to be applied.

2-8.2 In Process Inspections. These are inspections performed in the process of repairing the material, to insure that all parts conform to the prescribed repair standards, that the workmanship is in accordance with approved methods and procedures, and that deficiencies not disclosed by initial inspection are found and corrected.

2-8.3 Final Inspection. This is an acceptance inspection performed by a final inspector, after repairs have been completed, to insure that the material is acceptable for return to user or for return to replacement stock, according to established procedures.

2-9. Inspection Procedures

The inspection procedures for the rifle and bipod after disassembly are shown in Table 2-3, page 9, and specific instructions on inspection prior to disassembly are shown in paragraph 2-10 below.

CAUTIONS:

- 1. ENSURE THAT MAGAZINE IS REMOVED AND THE RIFLE IS NOT LOADED BEFORE STRIPPING, CLEANING OR INSPECTING SO THAT IT WILL NOT FIRE.**
- 2. WEAR SAFETY GLASSES IN CASE YOU LOSE CONTROL OF SOME SPRING LOADED COMPONENT WHICH COULD INJURE YOUR EYES.**
- 3. DO NOT PERMIT LIVE AMMUNITION IN OR NEAR THE WORK AREA.**

2-10. Inspection Prior to Disassembly

NOTE: Check to see that the rifle and accessories have been cleaned of all grease, oil, dirt, or foreign matter which might interfere with proper functioning or obscure the true condition of the parts.

2-10.1 Make an overall inspection of the rifle and accessories for general appearance, condition and operation.

2-10.2 On material turned in for repair, make an initial inspection to determine the extent of repair required and the basis of procuring the parts or assemblies necessary to accomplish the repair.

2-10.3 Refer to Chapter V, page 34 for functional inspections.

TABLE 2-3—MAINTENANCE INSPECTIONS

Field Inspection	Direct and General Support Inspection		Action	Reference
	Spot Check	Initial		
1. MAGAZINE ASSEMBLY				
X	X	—	A. Visually inspect magazine box for bulges, dents, cracks, bent cover lips, excessive wear, damaged feeder lips or bent or broken base plate retaining tabs.	
X	X	—	B. Check rear area of follower for chips or excessive wear which would impair functioning of the bolt catch.	
X	X	—	C. Examine springs for breaks, corrosion, or improper assembly to the follower.	
2. UPPER RECEIVER GROUP				
			A. General	
X	X	—	(1) Inspect for cracks or mutilation which would affect function. Small dents or gouges should not be cause for rejection.	
X	X	—	(2) Inspect all parts for wear or damage.	
X	X	X	(3) Check springs for breaks or deformations.	
			B. Handguard Assembly	
X	X	—	(1) Inspect for breaks and separation of handguard from liner.	

TABLE 2-3—MAINTENANCE INSPECTIONS (Cont.)

Field Inspection	Direct and General Support Inspection		Action	Reference
	Spot Check	Initial		
X	X	—	(2) Inspect for dents, cracks, or chipping that would impair the functioning of components or the weapon.	
			C. Barrel and Barrel Extension	
X	X	—	(1) Inspect surfaces for cracks or other defects.	
X	X	—	(2) Check barrel extension for burrs, or broken or worn locking lugs.	
X	X	—	(3) Check bore for cleanliness and freedom from corrosion.	
X	X	—	(4) Individual pits as large in diameter as a land or groove width are allowable in the bore only. Uniformly fine pits are acceptable in the bore.	
X	X	—	(5) When viewed with the naked eye, lands that appear dark due to coating of gilding metal from projectiles are allowable.	
X	X	—	(6) Definitely ringed bores or bores ringed sufficiently to bulge the outside surface of the barrel are cause for rejection.	

TABLE 2-3—MAINTENANCE INSPECTIONS (Cont.)

Field Inspection	Direct and General Support Inspection		Action	Reference
	Spot Check	In Process		
X	X	—	(7) Inspect for barrel erosion. A borescope or cystoscope will greatly assist in this inspection. Appreciable erosion can exist and the rifle may still target satisfactorily. Target group size obtained by test firing should be the final criterion used to judge the acceptability of the barrel. The maximum permissible group size should be established by the user.	
X	X	—	(8) Inspect chamber for cleanliness and freedom from carbon deposits and corrosion.	Figure 2-3, page 17
X	X	—	(10) Inspect chamber for pitting using chamber reflecting tool, p/n 62694. Position tool in chamber as shown in Figure 2-3. Slowly rotate the upper receiver so that the reflected light will illuminate the chamber walls. A pit or pits as large as 1/32 inch (0.794 mm) in diameter shall be cause for rejection. A small number of uniformly fine pits, (approximately .010 in. (0.254 mm diameter) shall be acceptable provided that cartridges fired in the weapon do not exhibit cases with unusual or noticeable deformation or marking of the case body or excessive offset of the extractor groove flange.	Figure 2-3, page 17

TABLE 2-3—MAINTENANCE INSPECTIONS (Cont.)

Field Inspection	Direct and General Support Inspection		Action	Reference
	Spot Check	In Process		
X	X	X	(11) Check headspace, using Headspace Gage T-27921.	Figure 2-2, page 16
X	X	—	D. Front Sight and Gas Tube	
X	X	—	(1) Check front sight for cracks and general condition.	
X	X	—	(2) Check front sight post and detent for rust or other deficiencies which could cause restricted movement.	
X	X	—	(3) Check gas tube for cracks, deformities, or eccentric wear at rear tip.	
X	X	—	E. Ejection Port Cover Assembly	
X	X	—	(1) Check for bent, twisted or dented cover.	
X	X	X	(2) Check detent, and C ring for breakage or corrosion.	
X	X	X	(3) Check for broken, or distorted cover spring.	
X	X	—	F. Forward Assist. Check for corrosion and free function.	
X	X	—	G. Rear Sight. Check for broken or corroded windage drum and for corrosion between sight leaf and receiver.	
3. BOLT CARRIER GROUP				
X	X	—	A. Check for cracks or deformities in bolt (cam pin hole area).	
X	X	—	B. Inspect bolt for pitted or chipped bolt face, elongated firing pin hole, or corroded ejector.	

TABLE 2-3—MAINTENANCE INSPECTIONS (Cont.)

Field Inspection	Direct and General Support Inspection		Action	Reference
	Spot Check	In Process		
X	X	X	C. Each bolt locking lug should be inspected periodically for cracks. Use a black light if available, otherwise use a glass of no more than 3X magnification. Particular attention must be given to the lugs adjacent to the extractor slot, particularly where the rear shoulder of the lug meets the bolt body. Bolt with lugs exhibiting cracking, or which are definitely suspect, will be replaced.	
X	X	X	D. Inspect for broken bolt rings and proper spacing in ring gaps. Ring gaps are to be staggered to prevent loss of gas pressure. Check effectiveness of rings as follows: With firing pin and cam pin removed, and bolt assembled to bolt carrier, hold carrier vertically with key pointing downward. Bolt should not drop out of carrier; if bolt drops out, replace bolt rings.	
X	X	—	E. Inspect firing pin for wear and burrs.	
X	X	X	F. Check firing pin protrusion, using gage 62679. Protrusion should be between 0.028 & 0.036 in. (0.711 mm-0.914 mm).	Figure 2-4, page 17
X	X	—	G. Check key and bolt carrier assembly for cracks, burrs, chips, rust, or blockage of the key bore and gas passages, and for a bent or dented carrier key.	

TABLE 2-3—MAINTENANCE INSPECTIONS (Cont.)

Field Inspection	Direct and General Support Inspection		Action	Reference
	Spot Check	In Process		
X	X	X	H. Check socket head cap screws. They must be properly tightened and staked. Check for evidence of gas leakage between carrier and key.	Figure 6-2, page 39
X	X	X	I. Inspect extractor assembly for cracks in the claw areas, elongated pivot holes, a bent or broken extractor spring, and damaged or missing rubber plug.	
X	X	X	J. Check for broken extractor pivot pin.	
4. LOWER RECEIVER GROUP				
X	X	—	A. General (1) Inspect for cracks, corrosion or mutilation which would affect functioning. Small dents or gouges will not be cause for rejection. Corroded areas should be noted for immediate repair.	
X	X	—	(2) Inspect all parts for wear and damage.	
X	X	X	(3) Check springs for breaks or deformation.	
—	X	X	(4) Check trigger pull, minimum 5.5 lb., maximum 8.5 lb (2.49 kg-3.86 kg).	
X	X	—	B. Stock Assembly (1) Inspect for breaks and separations of material which prevent proper retention or interference with proper functioning of weapon.	

TABLE 2-3—MAINTENANCE INSPECTIONS (Cont.)

Field Inspection	Direct and General Support Inspection		Action	Reference
	Spot Check	Initial		
X	X	—	(2) Inspect for dents, cracks and chipping that would impair the functioning of components or weapon.	
5. BIPOD AND CASE				
X	X	—	A. Inspect the bipod legs; they shall move freely from closed to open position under spring tension. Inspect for rust and shiny areas. Any found must be touched-up.	
X	X	—	B. Bipod must hold securely to the rifle.	
X	X	—	C. Check case for holes or torn stitches	
6. BAYONET AND SCABBARD				
X	X	—	A. Inspect bayonet for chipped or broken grips, missing grip screws, bent, rusted, or missing latches. Latches must open and close freely and bayonet must hold securely to carbine.	
X	X	—	B. Inspect scabbard for missing rivets, torn webbing, broken or cracked body and torn or missing lace. Check that snap fastener holds firmly.	

FIGURE 2-1 DISASSEMBLY OF REAR SWIVEL



A. REMOVING SWIVEL RETAINING SCREW

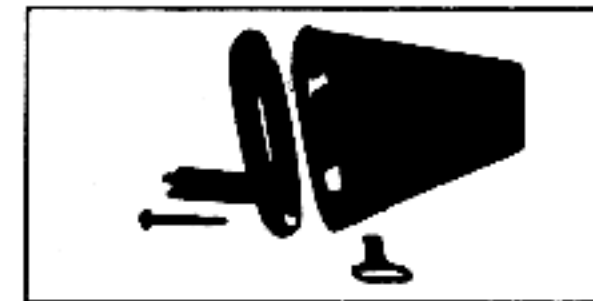

B. REAR SWIVEL REMOVED

FIGURE 2-2. HEADSPACE CHECK

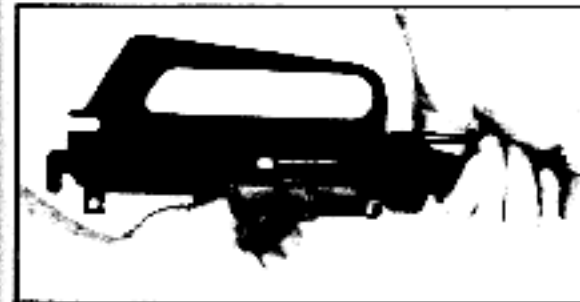
A. HEADSPACE GAGE INSTALLATION
(P/N T27821)

B. HEADSPACE GAGE INSTALLED

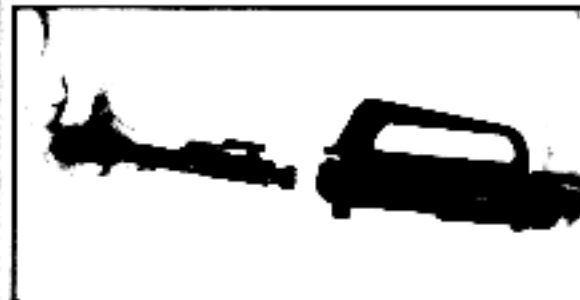

C. BOLT INSTALLATION

D. PROPER HEADSPACE INDICATION
BOLT WILL NOT GO TO LOCKED POSITION.

FIGURE 2-3. CHAMBER INSPECTION

CHAMBER
REFLECTOR
TOOL
(P/N 62694)A. CHAMBER REFLECTOR TOOL
INSTALLATIONB. CHAMBER VISUAL
INSPECTION

FIGURE 2-4. FIRING PIN PROTRUSION CHECK

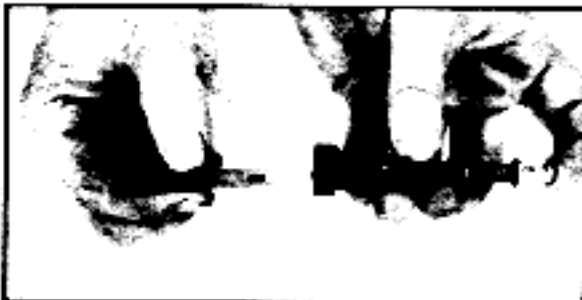
A. FIRING PIN PROTRUSION
GAGE (P/N 62679)

B. FIRING PIN PROTRUSION CHECK

NOTE: With the firing pin held firmly forward in the bolt, the end of the firing pin protrusion gage marked "MAX" ("GO"—.036 in, 0.91 mm) should pass over the end of the pin (See Figure 2-4) without touching it, and the end marked "MIN" ("NO-GO"—.028 in, 0.71 mm) should hit the end of the firing pin and not pass over it.

CHAPTER III—REPAIR INSTRUCTIONS

3-1. General

A. This section contains repair instructions and authorized direct and general support maintenance in the removal, disassembly, cleaning, inspection, lubrication, repair, and assembly of major groups and assemblies for the M16A1 Rifle and its accessories.

B. Refer to Table 3-1, page 19, for guide to maintenance functions.

C. Disassemble in accordance with the instructions contained in Colt Manual No. CM101, page 31, and Figures 3-1, through 3-3, pages 20-28 of this manual.

3-2. Replacement of parts

Replace all parts that are worn, damaged, cracked or broken. All replacement parts are interchangeable and require no adjustments at installation. However, to insure proper function and reliability, the following precautions should be taken:

3-2.1 Do not interchange bolts and bolt carriers unless replacement is necessary. Keep the bolt with the original bolt carrier.

3-2.2 If replacement of either part becomes necessary, carefully check the new part to see that it fits properly, operates smoothly, and that the proper head space is provided (See Figure 2-2, page 16).

3-2.3 If one or more rings of the bolt assembly are damaged, replace the three rings as a set.

3-2.4 When assembling a bolt with new rings into the bolt carrier, rotate the bolt while pushing it into the carrier to prevent damaging the rings. Move the bolt in and out several times to seat the rings.

3-2.5 If the bolt carrier key is replaced, it may be necessary to create a seal between the bolt carrier and key by firing 5 to 8 rounds. (Manual operation of the rifle may be required.) Sealing compound (Table 2-2, item 12, page 5.) may also be required prior to assembly of the key and bolt carrier. (See Chapter VI, paragraph 6-2.1.4 page 39.)

3-2.6 See page 31 for installation of replacement barrel and front sight assembly.

TABLE 3-1. GUIDE TO MAINTENANCE FUNCTIONS

COLT MANUAL NO. CM-101				COLT MANUAL NO. CM-102					
Item	Removal/ Installation	Disassembly	Cleaning	Lubrication	Assembly	Disassembly	Cleaning	Assembly	Repair
Magazine Assembly	Fig. 2-10, P.15	Fig. 3-8, P.37	Par. 3-5, P.31 and 3-11, P.49	Par. 3-7, P.41	Par. 3-8, P.43 and 3-14, P.50	Fig. 3-1, P.20			
Upper Receiver Group		Par. 3-4, P.31 and 3-10, P.44	Par. 3-5, P.31 and 3-11, P.49	Par. 3-7, P.41 and 3-13, P.50	Par. 3-8, P.43 and 3-14, P.50	Fig. 3-2, P.21	Table 3-2 Page 29	Par. 6-2, P.37	Chapter VI, P.35
Bolt Carrier Group		Par. 3-4, P.31 and 3-10, P.44	Par. 3-5, P.31 and 3-11, P.49	Par. 3-7, P.41 and 3-13, P.50	Par. 3-8, P.43 and 3-14, P.50		Table 3-2 Page 30	Par. 6-2, P.38	Chapter VI, P.35
Lower Receiver Group		Par. 3-4, P.31 and 3-10, P.44	Par. 3-5, P.31 and 3-11, P.49	Par. 3-7, P.41 and 3-13, P.50	Par. 3-8, P.43 and 3-14, P.50	Fig. 3-3, P.25	Table 3-2 Page 30	Par. 6-2, P.38	Chapter VI, P.35 (See NOTE below)
Bayonet and Subboard	Par. 4-3, P.58		Par. 4-4, P.59	Par. 4-4, P.59		Par. 4-2, P.32		Par. 4-2, P.33	Par. 4-2, P.32
Bipod	Par. 4-8, P.60		Par. 4-9, P.60	Par. 4-9, P.60					

NOTE: Weapons returned to direct maintenance because of jammed pivot pin detents and springs should be repaired as follows:

- A. Place forward portion of lower receiver in a container of penetrating oil, rifle bore cleaner, or carbon removing compound (cleaning solvent) and allow to soak for 24 hours.
- B. Remove the pivot pin, detent, and spring using a small piece of wire.
- C. After removal of parts, thoroughly clean the recess and parts and lubricate with LSA oil before assembly.

FIGURE 3-1. MAGAZINE DISASSEMBLY



A. REMOVE BOTTOM PLATE



B. REMOVE SPRING



C. REMOVE FOLLOWER

FIGURE 3-2. DISASSEMBLY OF UPPER RECEIVER GROUP

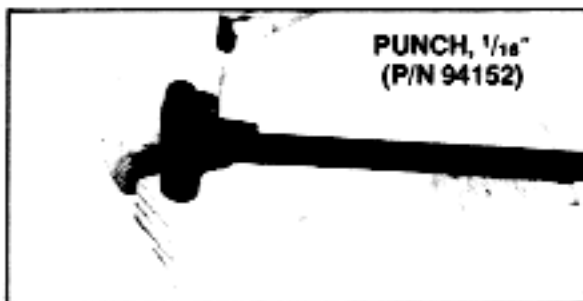

A. CHARGING HANDLE ROLL PIN REMOVAL

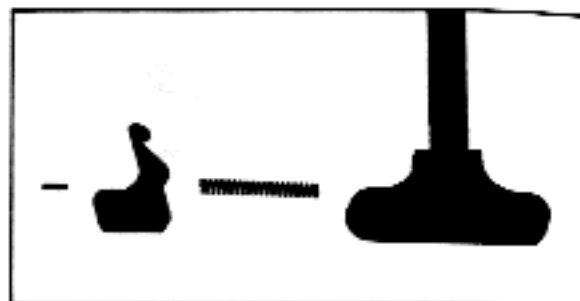

B. CHARGING HANDLE LATCH DISASSEMBLED.

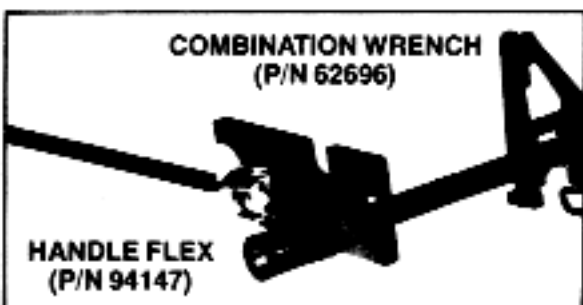

C. FLASH SUPPRESSOR REMOVAL (FOR ASSEMBLY TORQUE SEE PAGE 39)

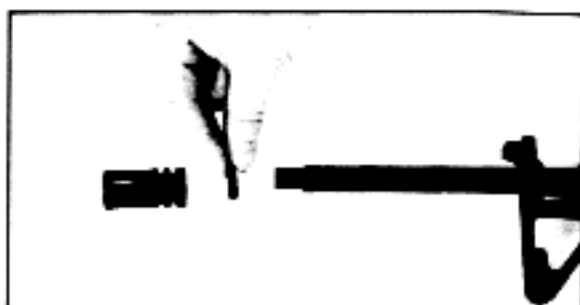

D. FLASH SUPPRESSOR REMOVED



E. FRONT SIGHT TAPER PIN REMOVAL (Starter punch is shown; the intermediate punch is then used, and taper pins are finally removed using the knock out punch.)



F. FRONT SIGHT TAPER PINS REMOVED

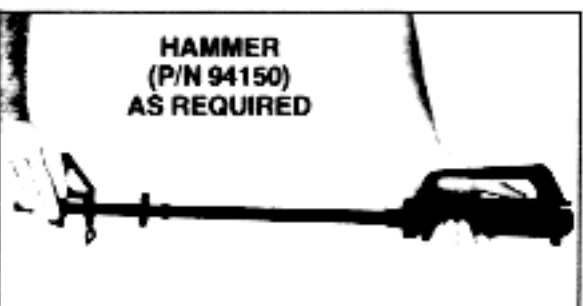

G. FRONT SIGHT REMOVAL

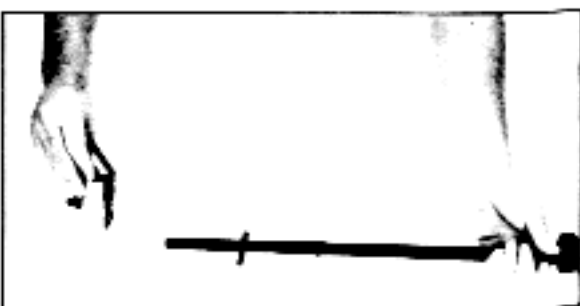

H. FRONT SIGHT REMOVED

FIGURE 3-2. DISASSEMBLY OF UPPER RECEIVER GROUP (Cont.)



J. GAS TUBE ROLL PIN REMOVAL (5/64" PUNCH, P/N 62697)

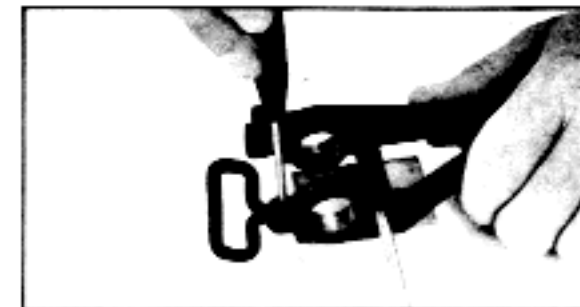

K. FRONT SWIVEL RIVET REMOVAL (1/8" PUNCH, P/N 94155)

Note: The swivel is attached by a rivet. The rivet may be removed by drilling off the flared end and punching out the remaining shank. When installing a new rivet, flare the end using the tool, swaging rivet. (P/N 62715)

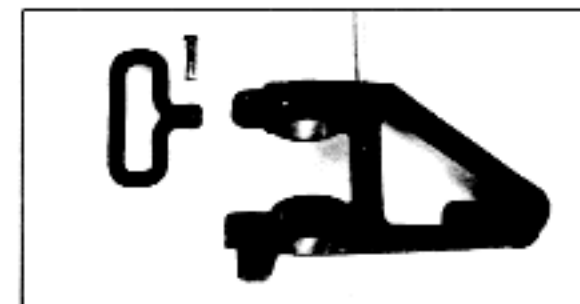

L. FRONT SWIVEL REMOVED



M. FRONT SIGHT POST REMOVAL (WRENCH, P/N 62699, DEPRESSOR, P/N 62672)



N. FRONT SIGHT POST REMOVED

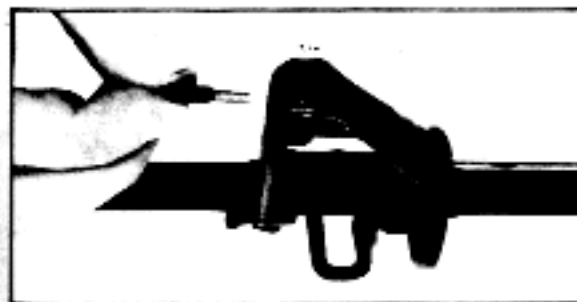

O. FRONT SIGHT DETENT AND SPRING REMOVED



P. BARREL NUT REMOVAL (WRENCH HANDLE P/N 94147 COMBINATION WRENCH P/N 62696)

FIGURE 3-2. DISASSEMBLY OF UPPER RECEIVER GROUP (Cont.)



Q. BARREL REMOVAL
(FOR ASSEMBLY TORQUE SEE PAGE 37)

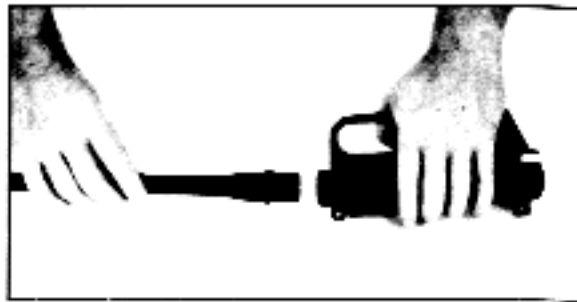

R. BARREL REMOVED

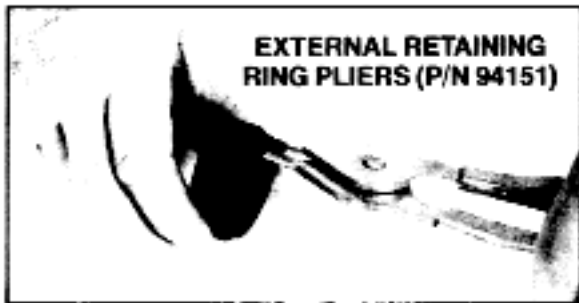

S. BARREL NUT DISASSEMBLY

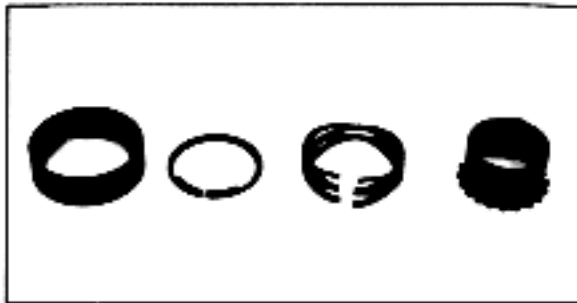

T. BARREL NUT DISASSEMBLED



U. EJECTION PORT COVER PIN REMOVAL
(Alternatively, if barrel is not to be removed, remove C clip from front of pin and withdraw pin to rear.)

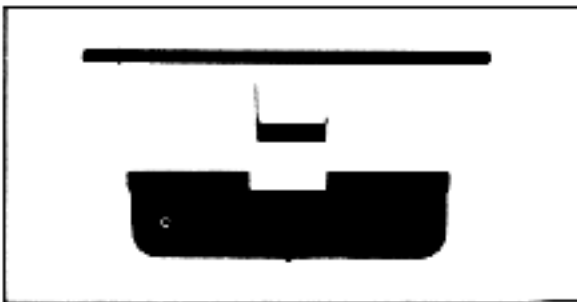

V. EJECTION PORT COVER REMOVED



W. WINDAGE DRUM ROLL PIN REMOVAL



X. WINDAGE DRUM ROLL PIN REMOVED

FIGURE 3-2. DISASSEMBLY OF UPPER RECEIVER GROUP (Cont.)

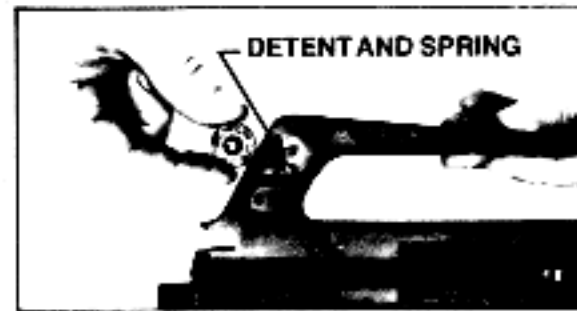

Y. WINDAGE DRUM REMOVED
(Also remove detent and spring)



Z. WINDAGE SCREW REMOVAL



AA. WINDAGE SCREW AND SIGHT LEAF REMOVED



AB. REAR SIGHT SPRING REMOVED

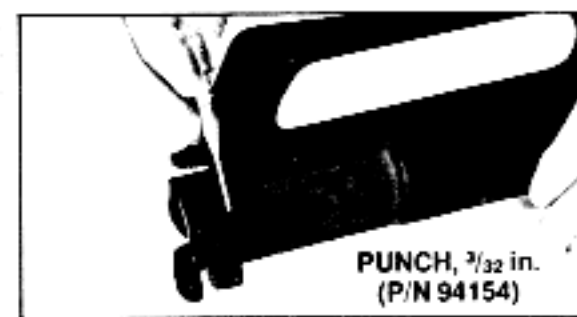

AC. FORWARD ASSIST ASSEMBLY ROLL PIN REMOVAL

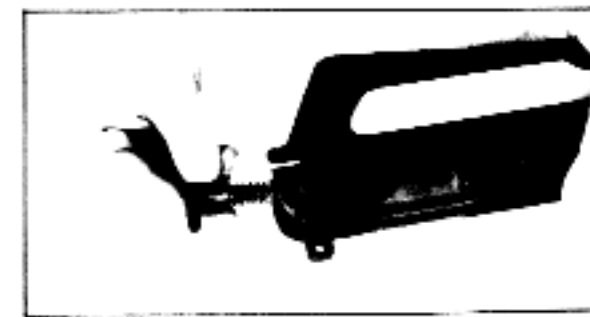

AD. FORWARD ASSIST ASSEMBLY REMOVED

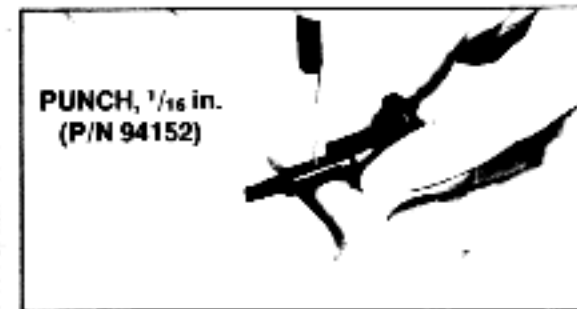

AE. FORWARD ASSIST PAWL ROLL PIN REMOVAL

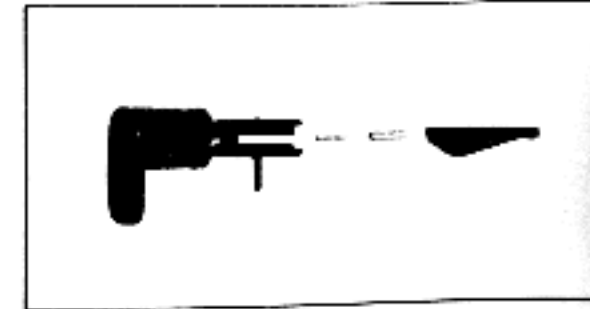

AF. FORWARD ASSIST PAWL DISASSEMBLED

FIGURE 3-2. DISASSEMBLY OF UPPER RECEIVER GROUP (Cont.)

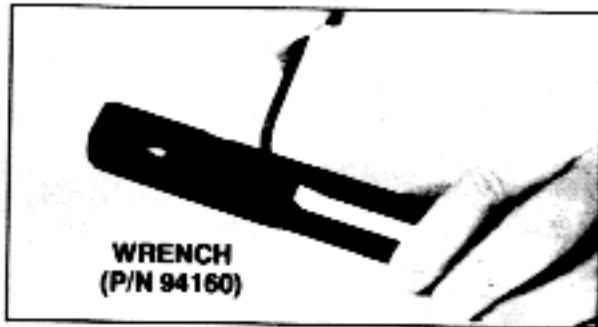

WRENCH
(P/N 94160)

AG. BOLT CARRIER KEY REMOVAL
(FOR ASSEMBLY TORQUE SEE PAGE 39)

For bolt carrier disassembly see CM101, figure 3-3, page 33.

Note: The staked socket head screws may be difficult to remove. If so, file off sufficient staked material to remove screws and replace key and screws with new components.

FIGURE 3-3. DISASSEMBLY OF LOWER RECEIVER GROUP

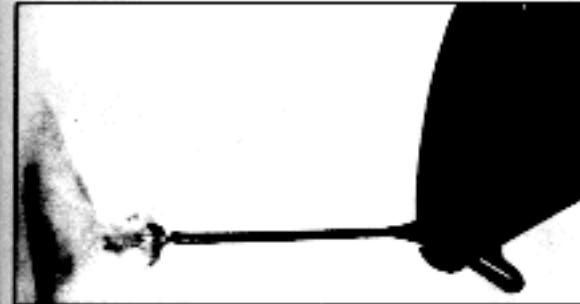

A. REAR SWIVEL SCREW AND BUTTPLATE
REMOVAL



B. REAR SWIVEL & BUTTPLATE REMOVED



C. LOWER RECEIVER EXTENSION REMOVAL

WRENCH, ADJUSTABLE,
OR WRENCH, COMBINATION
P/N 62696 AND HANDLE,
FLEX, P/N 94147



D. LOWER RECEIVER EXTENSION REMOVED

CAUTION: DETENTS AND SPRINGS ARE UNDER TENSION AND WILL FLY OUT OF THE HOUSING UNLESS CAREFULLY CONTROLLED.

FIGURE 3-3. DISASSEMBLY OF LOWER RECEIVER GROUP (Cont.)

FIGURE 3-3. DISASSEMBLY OF LOWER RECEIVER GROUP (Cont.)

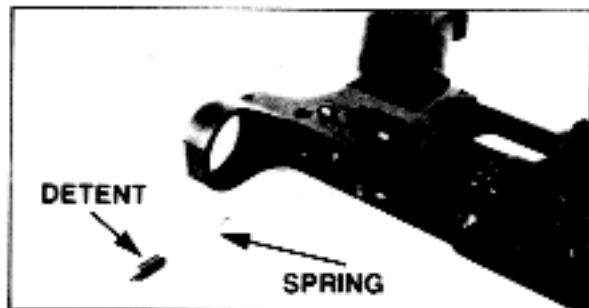

E. REMOVE/INSTALL DETENT AND SPRING.



F. TRIGGER GUARD ROLL PIN REMOVAL



K. PISTOL GRIP REMOVAL
(ALSO SEE CM101 FIG. 3-15, P. 47)



L. HAMMER REMOVAL



G. BOLT CATCH PIN REMOVAL

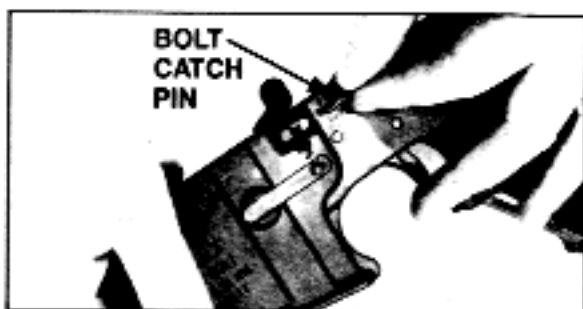

H. BOLT CATCH PIN REMOVED



M. AUTOMATIC SEAR REMOVAL



N. SELECTOR LEVER REMOVAL

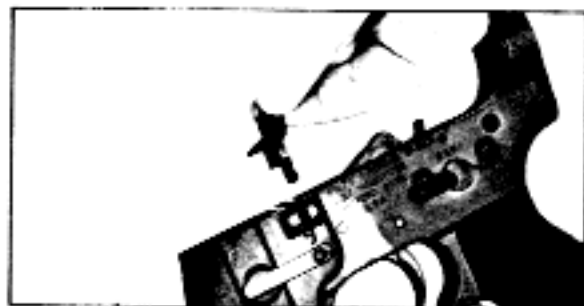

I. BOLT CATCH REMOVED.



J. BOLT CATCH SPING AND
PLUNGER REMOVED

3-3. Cleaning and Lubrication

Clean and lubricate the material as instructed in Colt Manual No. CM101, paragraphs 3-5, page 31. Also comply with the additional instructions in Table 3-2 below.

TABLE 3-2—CLEANING AND LUBRICATION

Item	Action Required
Barrel	If hard carbon is still evident in the chamber after cleaning, dip soak chamber and reclean. Dry thoroughly with swabs.
Barrel Nut Assembly	A. Remove all evidence of dirt or rust. B. Prior to assembly, apply a coating of LSA oil to components of barrel nut assembly with the exception of the barrel nut threads which should be coated with molybdenum disulfide grease.
Front Sight Assembly	Apply a generous coat of LSA oil to the front sight post, detent, and spring prior to assembly.
Gas Tube	Remove carbon deposits from the exterior surface of the tube. IMPORTANT: Do not use any type of abrasive material to clean the gas tube. A .063 in (1.60 mm) to .076 in. (1.93 mm) diameter spring wire may be used to dislodge deposits inside the tube.
Upper Receiver Group	A. Apply a generous coat of LSA oil to all internal surfaces and a light coat to all external surfaces prior to assembly. IMPORTANT: Do not use a wire brush on aluminum surfaces such as the receivers. B. Prior to assembly, thoroughly lubricate the ejection port cover, and all components of the forward assist and front sight assemblies with LSA oil. NOTE: The ejection port cover latch shall not be disassembled. If the latch is inoperative, the ejection port cover assembly must be replaced.

TABLE 3-2—CLEANING AND LUBRICATION (CONT.)

Item	Action Required
Bolt Carrier Group	A. Clean the extractor recess in the bolt. B. Clean the gas exhaust ports in the bolt carrier with a hand-held No. 36 drill (.106 in, 2.69 mm).
Lower Receiver Group	A. Prior to assembly, apply a generous coat of LSA oil to all functional parts. B. Lubricate the threads of the lower receiver extension with a coat of molybdenum disulfide grease. NOTE: Dry cleaning solvent may be used to clean or wash grease or oil from all parts of rifle and bipod.
General	Component parts which contain a hard carbon, such as the flash suppressor, barrel bore, bolt carrier group, will require special cleaning using carbon removing compound. CAUTION: FOLLOW SAFETY PRECAUTIONS FOR HANDLING CARBON REMOVING COMPOUND TO PREVENT SKIN OR EYE DAMAGE. A. Fill a suitable container with fresh compound. B. Remove all grease, dirt and oil before soaking components in compound. Completely immerse parts to be cleaned in compound. C. Soak for 2 to 16 hours. Remove parts and allow to drain. Rinse in dry cleaning solvent. Brush with a stiff bristle brush under running water to effectively remove carbon.

Table 3-3 INSTALLING A REPLACEMENT BARREL AND FRONT SIGHT ASSEMBLY

When installing a replacement barrel and front sight assembly, part no. 62744, note that it includes the barrel, front sight assembly, barrel nut and cap handguard. See item no. 8 on Figure B-1, page 52 for illustration of components.

Step	Action	Reference
1	CLEAR RIFLE	
2	Disassemble by separating receivers and removing bolt carrier assembly and charging handle.	CM101, Par. 3-4, page 31, steps A, B and C
3	Remove flash suppressor and lock washer and retain for assembly on new barrel.	CM102, Fig. 3-2, page 21, steps C and D
4	Remove gas tube roll pin.	CM102, Ch. III, Fig. 3-2, page 22, step J
5	Remove gas tube by pushing it back through barrel nut until front end is clear of front sight assembly and cap handguard. Then, pull gas tube clear and forward out of the barrel nut. Retain gas tube for assembly to new barrel and ensure that it is not bent or dented.	
6	Remove barrel nut and barrel from upper receiver.	CM102, Ch. III, Fig. 3-2, page 22 and 23, steps P, Q, and R
	When assembling barrel and barrel nut to receiver use the barrel nut aligning tool which must be installed in the carrier key.	CM102, Ch. IV, Fig. 6-1, page 38, steps A, B and C
7	Disassemble barrel nut components leaving barrel nut on barrel. Retain snap ring, handguard; slip ring, handguard; and spring for new barrel nut.	CM102, Ch. III, Fig. 3-2, page 23, steps S and T
8	Install replacement barrel and front sight assembly, and reassemble rifle by following this procedure in reverse order and the instructions given for installing a barrel.	CM102, Ch. IV, par. 6-2.1.2 page 37

CHAPTER IV—MATERIAL USED IN CONJUNCTION WITH MAJOR ITEM

4-1. General

The Bayonet-Knife, U.S. Model M7; and Bayonet-Knife Scabbard, U.S. Model M8A1, are used in conjunction with the major item. Refer to Manual CM101 for operator and organization maintenance instructions.

4-2. Direct and General Support Maintenance

4-2.1 Disassembly.

Refer to Figure 4-1, page 33.

NOTE: Prior to disassembly, it is recommended that the right hand release and plate be marked to assist in identification when assembling the left and right hand releases (See Figure 4-1, page 33).

4-2.2 Cleaning.

Refer to Manual CM101, page 31.

4-2.3 Inspection and Repair

4-2.3.1. Bayonet-Knife

- Replace screws, if threads are stripped.
- Replace cracked grips.
- Replace spring pin if worn or damaged.
- Replace spring if kinked, set, or broken.
- Remove nicks and dents, as required by grinding and/or stoning.
- If wear is noted on the release camming area and positive retention to the rifle is questionable, replace as required. If binding is noted due to a bent release, repair by straightening or replace release.
- Use flat black lacquer if shiny surfaces are on handle of blade.

4-2.3.2. Bayonet-Knife Scabbard, U.S. Model M8A1.

- Metal parts will be dark. If the finish of metal is worn, flat black lacquer may be applied.
- If the scabbard is chipped, exposing the fabric or the surface is scratched or marred, smooth as required and paint with olive drab lusterless enamel.
- Clean and/or replace broken or damaged lace.

FIGURE 4-1. BAYONET-KNIFE DISASSEMBLY

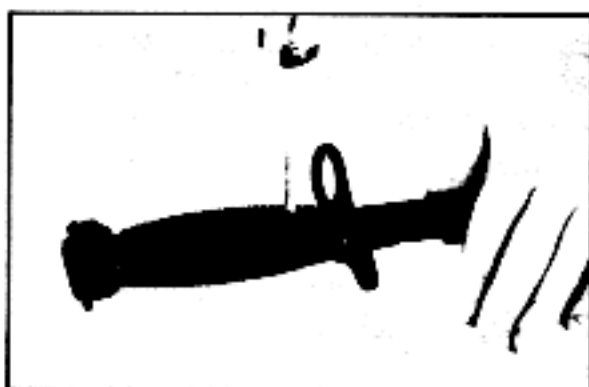

A. GRIP REMOVAL

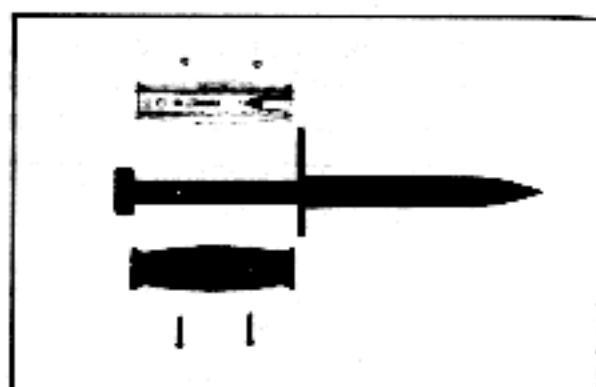

B. GRIPS REMOVED

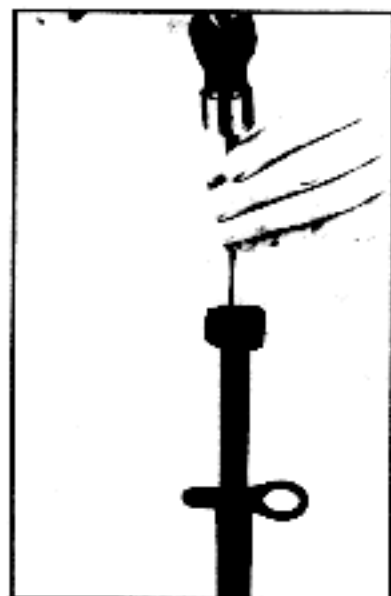

C. RELEASE DISASSEMBLY



D. RELEASE DISASSEMBLED

4-2.4 Assembly.

Assemble by reversing procedure in Figure 4-1.

CHAPTER V—FINAL INSPECTION**5-1. General**

This chapter contains instructions for the final inspection of repaired rifles and bipods. As applicable, the rifles and bipods must be checked in accordance with the procedures outlined in Table 2-3, page 9, and in paragraphs 5-1.1 through 5-1.3 which follow. Rifles that have been repaired shall be function fired to assure proper function. Rifles that have been rebarreled should be both function fired and fired for accuracy.

5-1.1 Visual Inspection

Overall appearance shall be approximately that of a new weapon. All exposed metal surfaces are to have a dull, rust or corrosion resistant finish with no burrs or deep scratches. Barrels must be straight, clean, free of rust, powder fouling, large pits, bulges, or rings. Fine pitting is allowable. Rifles must be complete with no missing parts. The serial numbers must be legible. All steel parts must be free of rust. Roll pins must be secure and screws must be tight. Check to be sure that all modifications authorized to date have been incorporated.

5-1.2 Functional Inspection

The instructions for accomplishing a functional inspection are contained in Colt Manual No. CM101, Chapter II, Section 5, page 25.

5-1.3 Inspection of Critical Dimensions

Inspect for dimensional acceptability of headspace, firing pin protrusion, barrel straightness, and extent of barrel erosion in accordance with the instructions contained in Table 2-3, page 9.

CHAPTER VI—REPAIR, REFINISHING, AND REASSEMBLY

6-1. Repair and Refinish Procedures

Approved procedures for repair and refinishing of various surfaces of the rifle are as follows:

6-1.1 Repair Procedures

The recommended repair procedures are by the application of touch-up coatings and/or replacement of parts.

NOTE: Stoning in accordance with standard shop procedures is permitted in non-critical areas for removal of minor burrs, nicks, or slight surface imperfections. **Extreme care must be exercised** to preclude alteration of critical characteristics. Touch-up of the stoned surface should be done as soon as possible after stoning or other abrasive procedures to prevent contamination or corrosion of the exposed surface.

6-1.1.1 Dents and Gouges

(A) **Smooth** the periphery of the defect by filing, scraping, sanding, buffing, or other appropriate means to improve the appearance and to establish a clean, firm contact area for the touch-up material.

(B) **Wash** the area with solvent cleaning compound (Table 2-2, item 3, page 5) to remove all dust, grease, or other foreign particles.

(C) **Dry** the surface, **apply** the touch-up finish, and **cure** it in accordance with the instructions furnished by the manufacturer. The lacquer in Table 2-2, item 6 page 5 should be used on all exposed, exterior surfaces of aluminum parts. The touch-up lacquer may also be used on clean steel surfaces which are exposed and are not subjected to heat.

6-1.1.2 Corroded Components

Corroded components, particularly the upper and lower receiver extension, may be repaired when removal of the corrosion is possible by light sanding or buffing operations which will return the affected surface to a smooth condition for touch-up. Affected area shall be cleaned and refinished as specified in paragraph 6-1.1.1 above.

6-1.2 Corrective Action for Unusual Malfunctions

Cartridge Case Rim Shear

If the case cannot be removed from the chamber by the standard procedure (actuation of the bolt assembly), a cleaning rod may be inserted into the muzzle and the case may be pushed out of the chamber. If the chamber is found to be pitted, replace the barrel and front sight assembly.

6-2. Reassembly

Reassembly of the major groups shall include all necessary adjustments, specified torque applications (as indicated, using properly calibrated and maintained equipment), and a constant quality assurance surveillance to insure that included parts, components, subassemblies, and/or assemblies conform to all criteria as specified in this manual. Torque wrenches listed in Table 2-1, page 3, shall not be considered as mandatory. However, the wrenches listed, with their inherent functional characteristics should fully satisfy all requirements contained in this manual. When installing the various roll pins, the ¼ in. punch (p/n 94156) shall be used in all cases in order to avoid damaging the pins or driving them in too far.

NOTE: LSA oil or equivalent shall be applied to all moving contact surfaces during reassembly. Emphasis is directed to all coil springs, particularly detent springs, and associated detents, plungers, and/or retainers. The fire control selector must also be lubricated at assembly.

The material shall be reassembled as specified in the following paragraphs.

6-2.1. Upper Receiver Group

The upper receiver group shall be reassembled by reversing the disassembly procedure and in accordance with the following instructions.

6-2.1.1 Front Sight.

Visually align front sight taper pin holes before installation of new taper pins. Install pins from right side with uniform application of force, using punch, p/n 62682. Support the front sight on a block of wood. Force applied shall not cause larger end of taper pin to enter to the point of being flush with sight frame surface. However, leading or small end of taper pin shall be flush or above sight frame surface after application of above force.

6-2.1.2 Barrel.

During installation of barrel assembly into the upper receiver, extreme care must be exercised to preclude damage to the upper receiver alignment slot by the barrel assembly alignment pin. Pin must enter slot, without deformation of the slot walls, to the depth necessary to accomplish full contact between the barrel assembly collar and the receiver. The threads of the barrel nut and the receiver shall be coated with molybdenum disulfide grease, page 5, item 5, prior to assembly. Initial torque applied to the barrel nut shall be 30 ft lbs (4.15 kg m) using torque limiting wrench, p/n 94162, and the combination wrench, p/n 62696, and with the barrel held in the barrel removal vise jaws, p/n 62695, in a bench vise. (See Figure 6-1B.) Additional torque shall be applied as necessary to create clearance for free entry of the gas tube through the barrel nut, using the barrel nut alignment tool, p/n 62693, as shown in Figure 6-1A and C.

FIGURE 6-1. BARREL NUT AND GAS TUBE/FRONT SIGHT ASSEMBLY INSTALLATION



A. BARREL NUT TORQUING.*

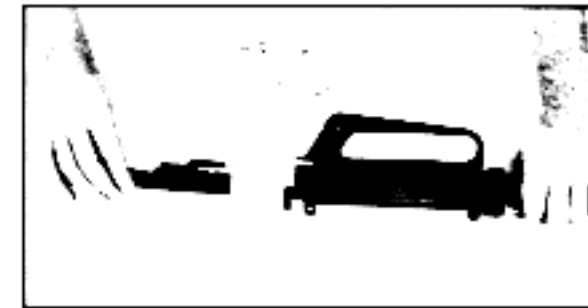

B. BARREL NUT ALIGNMENT TOOL (P/N 62693) INSTALLED IN KEY.



C. BARREL NUT INSTALLED AND ALIGNED.

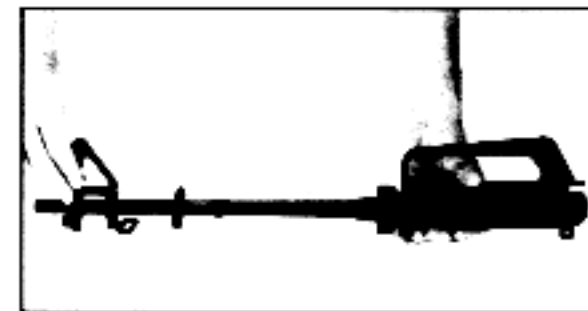

D. GAS TUBE AND FRONT SIGHT ASSEMBLY INSTALLED.

***NOTE:** MAKE CERTAIN ALL THREE PINS OF THE COMBINATION WRENCH ARE FULLY ENGAGED WITH THE BARREL NUT.

6-2.1.3 Flash Suppressor

Install the flash suppressor and lock washer with a torque of 25-30 ft lbs (4.15-5.53 kg m), using the combination wrench (P/n 62696) and the torque limiting wrench (p/n 94162), with the barrel held in the barrel removal vise jaws (p/n 62695) in a bench vise.

6-2.1.4 Bolt Carrier Group

See Colt Manual CM101, page 33, for assembly instruction. When installing the bolt carrier key, apply a thin coat of sealing compound (Table 2-2, item 12, page 5) to the undersurface of the key, being careful not to plug the gas port. Tighten the two socket head cap screws to a torque of 35-40 in. lbs (0.40-0.46 kg m) using the torque limiting wrench (p/n 94161) and the socket head hex bit wrench socket (p/n 94158) as shown in Figure 6-2a. The two socket head screws shall then be staked to the key at two points using the center punch (p/n 94146) as shown in Figure 6-2b below.

FIGURE 6-2. BOLT CARRIER KEY INSTALLATION

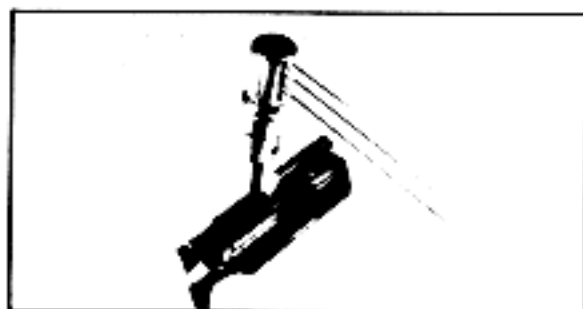

A. TORQUING KEY SCREWS
(35-40 IN. LBS.)

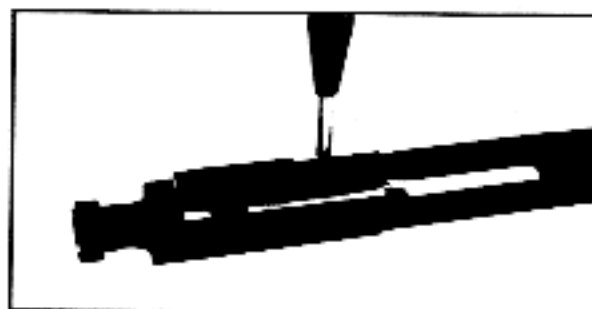

B. STAKING KEY SCREWS.

6-2.1.5 Lower Receiver Group

See Colt Manual No. CM 101, page 50, for assembly instructions which are not included in this manual. Refer to Figure 6-3, page 41, for installation of the pivot pin detent and spring using the pivot pin detent installation tool. Particular care should be exercised during installation of the hammer assembly to insure that the ends of the hammer spring are resting on the upper surface of the trigger pin as the hammer spring acts as a retainer for the trigger pin. (See Figure 6-4, page 42). (See Figure 6-5 for receiver extension and buttstock installation.)

FIGURE 6-3. PIVOT PIN DETENT INSTALLATION

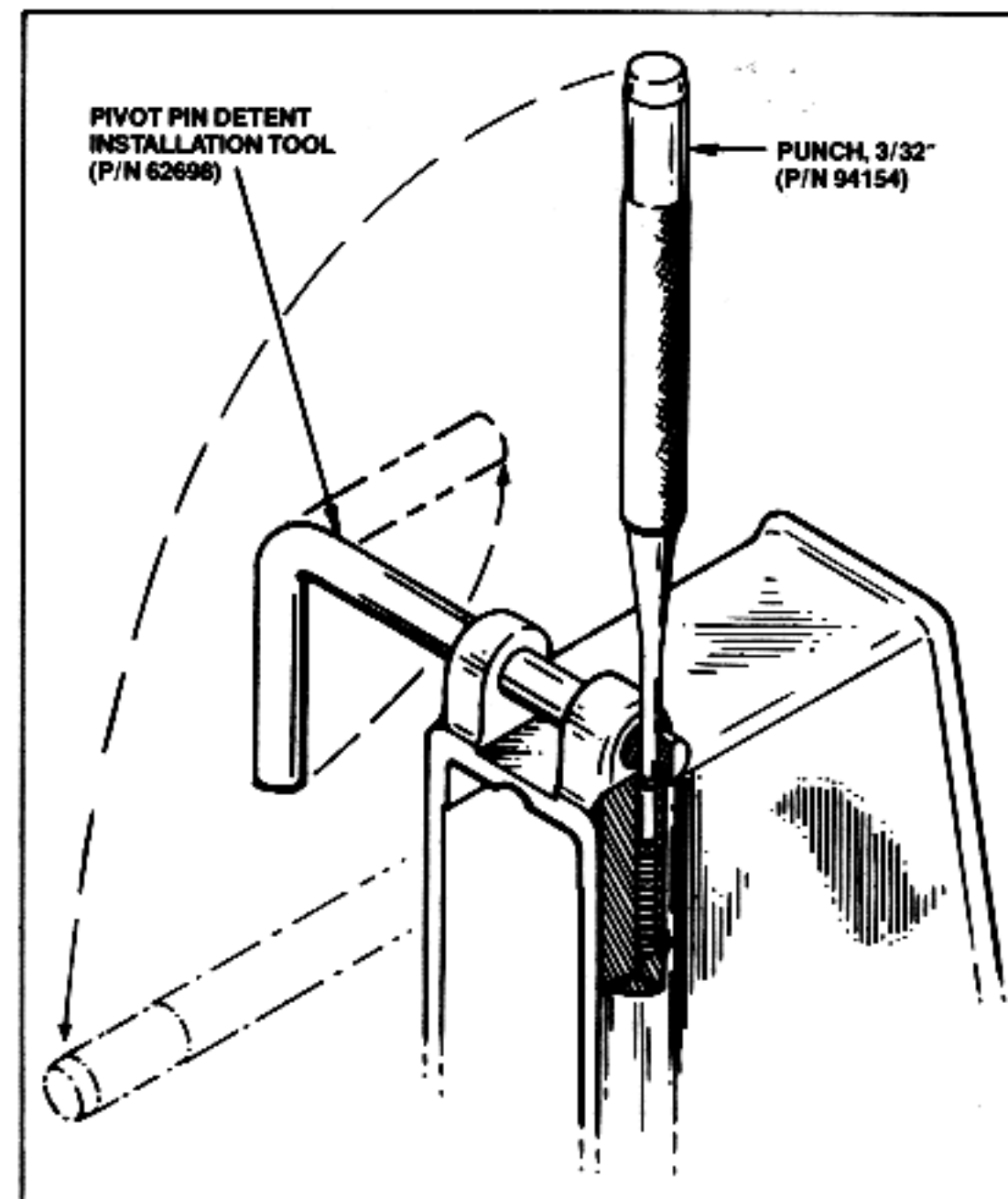

A. DETENT AND DETENT SPRING INSTALLATION.

FIGURE 6-3. PIVOT PIN DETENT INSTALLATION (CONT.)

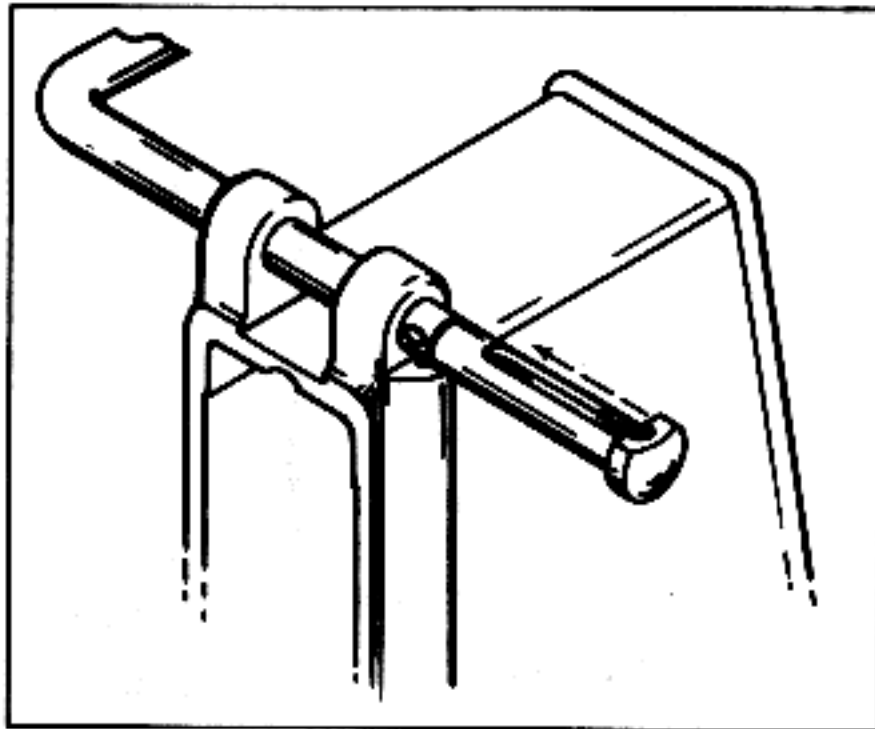

B. PIVOT PIN INSTALLATION

- | Step | Action |
|------|---|
| A. | Insert the pivot pin detent installation tool (p/n 62698) in the pivot pin holes of the lower receiver as shown in Figure 6-3A. |
| B. | Slide the installation tool in sufficiently to locate its hole directly over the detent cavity. |
| C. | Insert detent spring and detent through the hole in the installation tool and into the detent cavity. |
| D. | Press the detent into the cavity with the 3/32 in. punch (p/n 94154) but stop the punch just at the top of the cavity. |
| E. | Rotate the installation tool and punch 90°. |
| F. | Hold the pivot pin firmly against the installation tool and push the installation tool out as shown in Figure 6-3B. |
| G. | Rotate the pivot pin until the pivot pin drops into the pivot pin detent groove. |

FIGURE 6-4. HAMMER SPRING AND TRIGGER PIN INSTALLATION

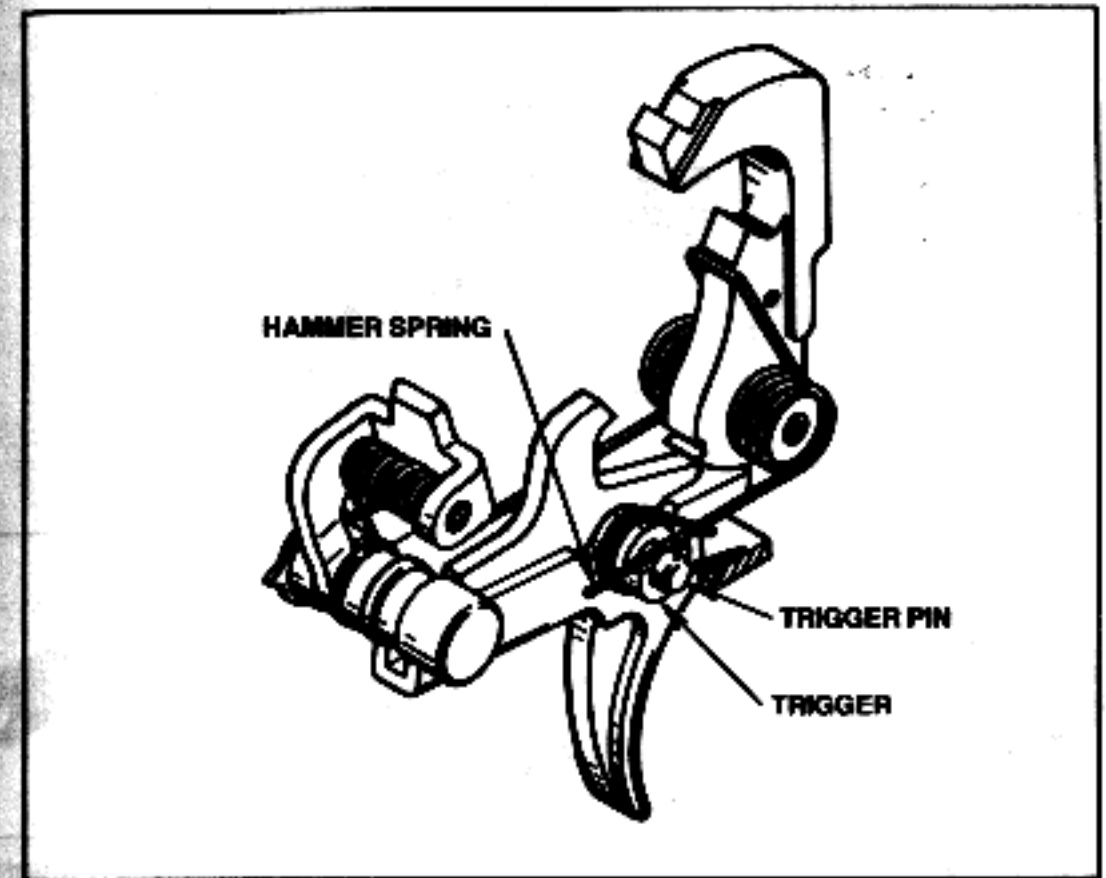
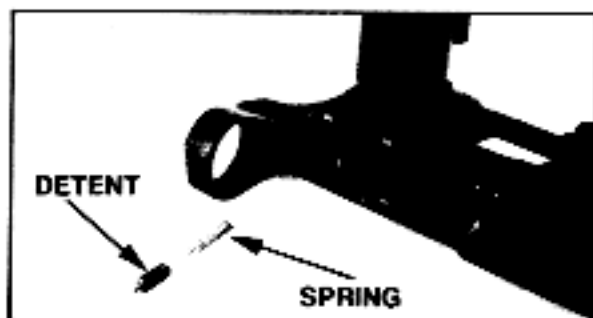

FIGURE 6-5. RECEIVER EXTENSION AND BUTTSTOCK INSTALLATION



A. INSTALL DETENT AND SPRING.



B. SCREW RECEIVER EXTENSION ONTO RECEIVER.



C. TIGHTEN LOWER RECEIVER EXTENSION ENSURING THAT BUFFER RETAINING DETENT IS SECURE BUT FREE TO MOVE IN ITS HOUSING.*

*IT IS RECOMMENDED THAT THE RECEIVER EXTENSION BE TORQUED TO 35-39 FT LBS (4.84-5.39 kg m) USING TORQUE WRENCH 94162 COMBINED WITH WRENCH 62420.

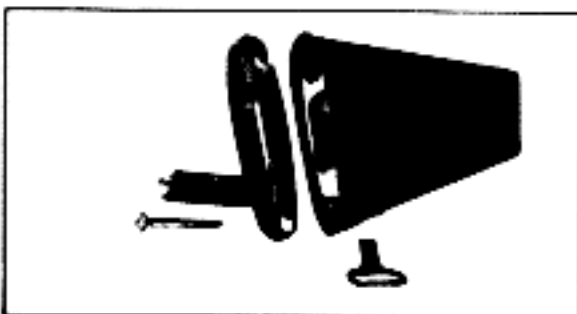

D. REAR SWIVEL & BUTTPLATE INSTALLATION.

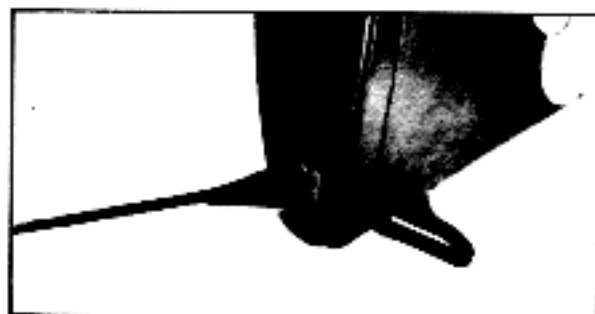

E. REAR SWIVEL SCREW AND BUTTPLATE SECURED.

APPENDIX A

BORE AND CHAMBER CLEANING TOOLS

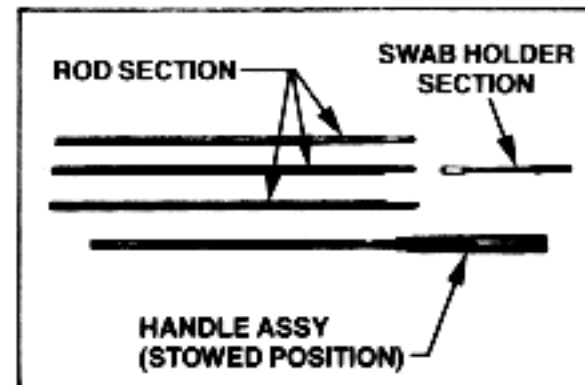
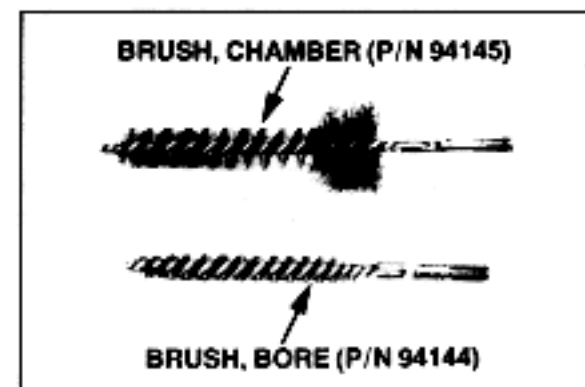

ROD, CLEANING (P/N 62702)

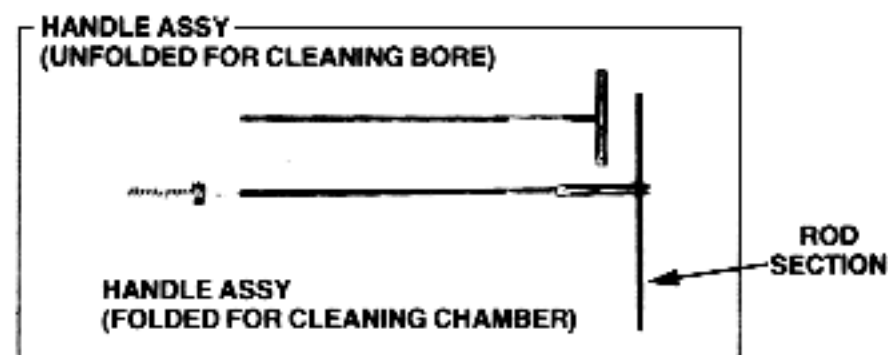

FIGURE A-1. BORE AND CHAMBER CLEANING TOOLS

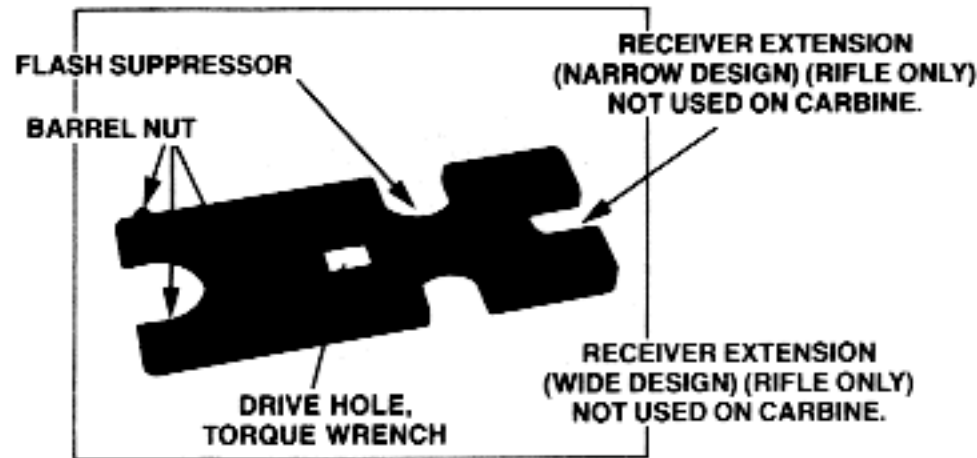

FIGURE A2. COMBINATION WRENCH (P/N 62696)
(SEE FIG'S 3-2C, PAGE 21, 3-2P, PAGE 22 and 3-2Q, PAGE 23)



FIGURE A3. REFLECTOR TOOL
(P/N 62694)



FIGURE A4. HEADSPACE GAGE
(P/N T27921)
(SEE FIG. 2-2, PAGE 16)

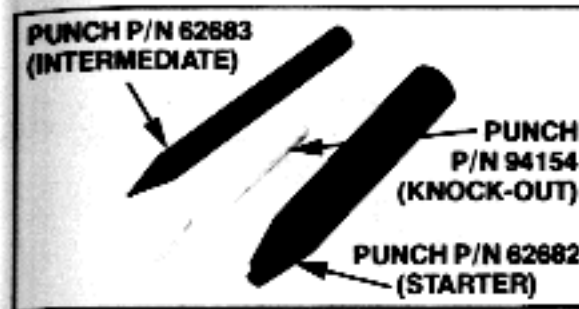

FIGURE A5. PUNCH SET FOR FRONT SIGHT
TAPER PIN REMOVAL AND INSTALLATION
(SEE FIG. 3-2E, PAGE 21)

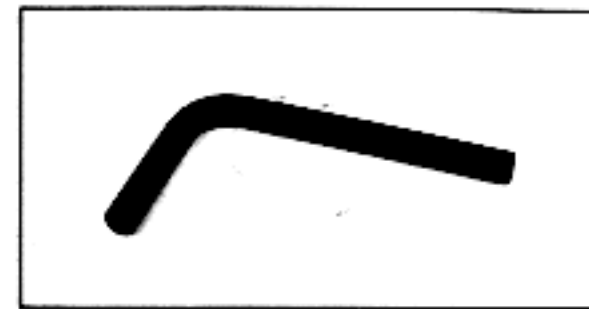

FIGURE A6. PIVOT PIN DETENT INSTALLATION
TOOL (P/N 62698)
(SEE FIG. 6-3A, PAGE 40 and 6-3B, PAGE 41)

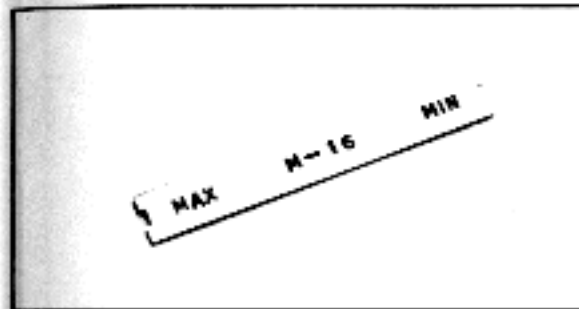

FIGURE A7. FIRING PIN PROTRUSION GAGE
(P/N 62679)
(SEE FIG. 2-4, PAGE 17)

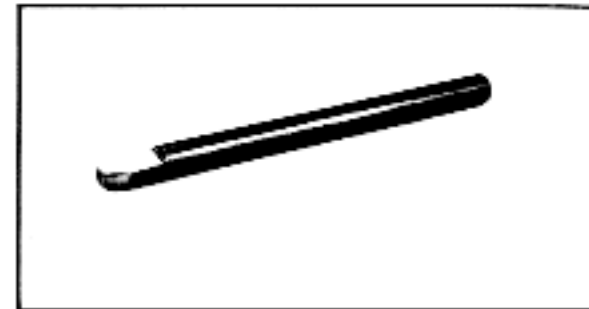

FIGURE A8. PUNCH SETTER (P/N 62692)
(WINDAGE DRUM ROLLPIN)



FIGURE A9. BOLT CATCH PIVOT
PIN PUNCH (P/N 62680)
(SEE FIG. 3-3K, PAGE 28)

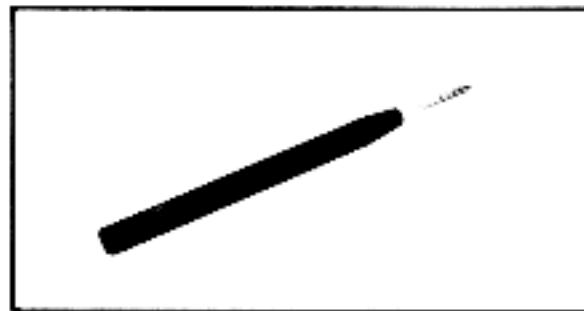

FIGURE A10. GAS TUBE ROLL
PIN PUNCH (P/N 62687)
(SEE FIG. 3-2J, PAGE 22)

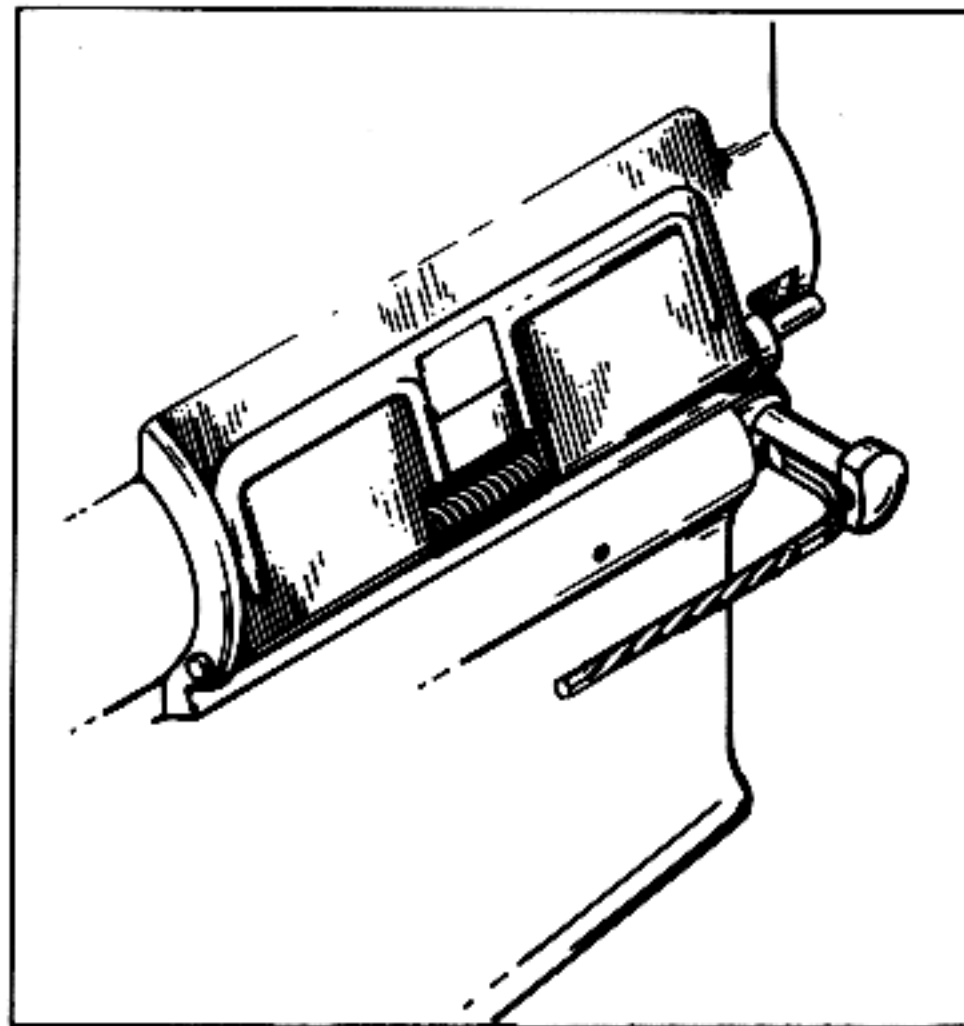

FIGURE A11. PIVOT PIN DETENT DEPRESSOR (P/N 62673).

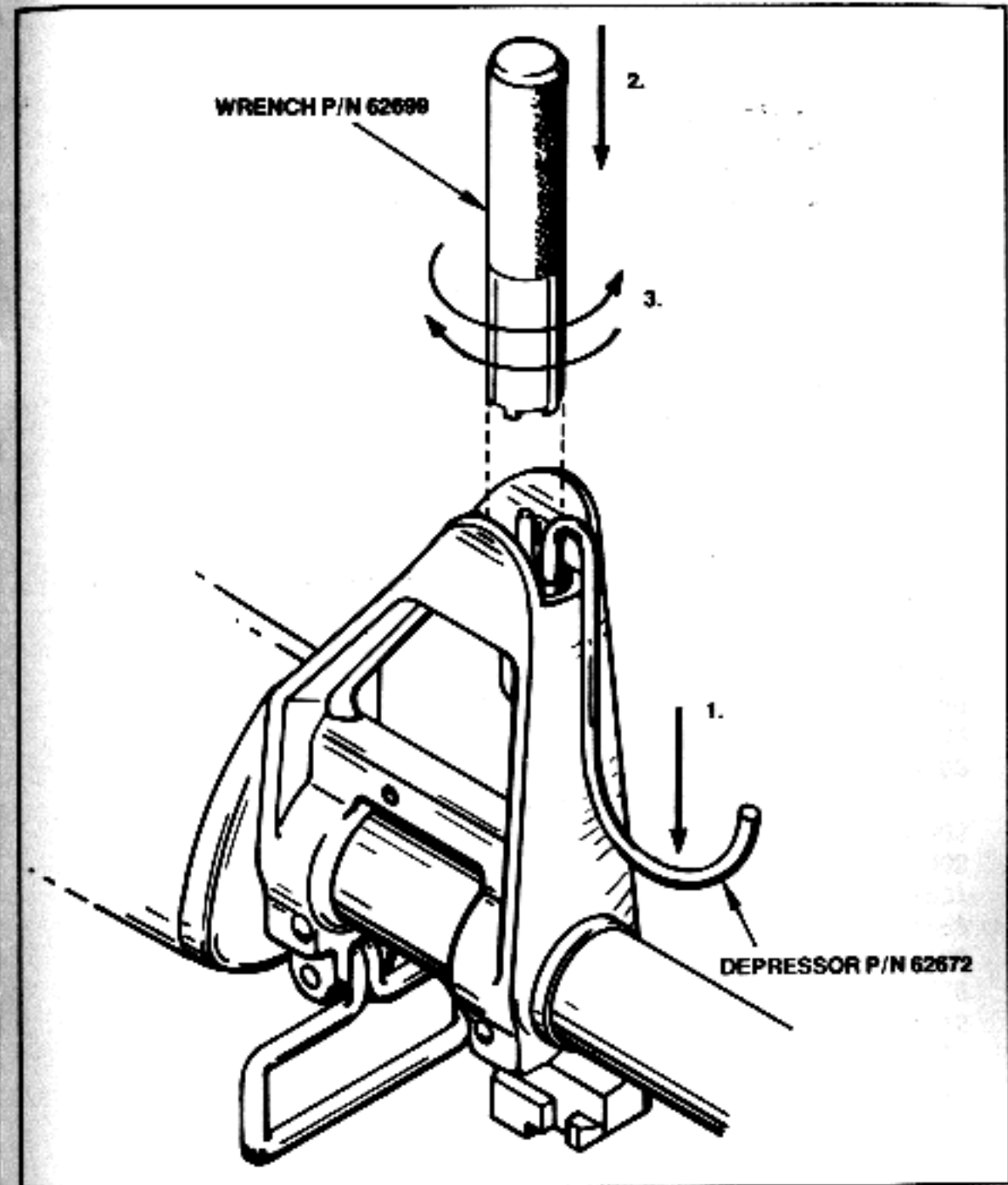

FIGURE A12. FRONT SIGHT POST TOOLS.
(SEE FIG. 3-2M, PAGE 22)



FIGURE A13. BARREL REMOVAL VISE JAWS (P/N 62695)

APPENDIX B

REPLACEMENT PARTS LIST

Figure No.	Page	Nomenclature	Part No.
		UPPER RECEIVER GROUP	
B1-1	52	Charging Handle Assembly	62290
B1-2	52	Pin, Roll Latch, Pivot**	95113
B1-3	52	Latch, Charging Handle	62289
B1-4	52	Spring, Charging Handle Latch	61875
B1-5a	52	Handguard Assembly RH	62198
B1-5b	52	Handguard Assembly LH	62198
B1-6	52	Suppressor, Flash	62348
B1-7	52	Washer, Lock	62126
B1-8	52	Replacement Barrel & Front Sight Assembly	62744
B1-9	52	Post, Front Sight	61706
B1-10	52	Detent, Front Sight	61705
B1-11	52	Spring, Front Sight Detent	61709
B1-12	52	Pin, Taper, Front Sight	62086
B1-13	52	Swivel, Sling, Forward	62280
B1-14	52	Rivet, Front Swivel	91209
B1-15	52	Cap, Handguard	62087
B1-16	52	Pin, Roll, Gas Tube	95108
B1-17	52	Gas Tube Assembly	61645
B1-18	52	Snap Ring, Handguard	90403
B1-19	52	Spring, Weld Assembly, Handguard Slip Ring	61962
B1-20	52	Nut, Barrel	61902
B1-21	52	Slip Ring, Handguard	61901
B1-22	52	Pin, Cover Hinge	61658
B1-23	52	Ring, Retaining, Ejection Port Cover	90402
B1-24	52	Spring, Ejection Port Cover	61518
B1-25	52	Ejection Port Cover Assembly	62112
B1-26	52	Pin, Roll, Rear Sight Drum**	95101
B1-27	52	Drum, Windage	61703
B1-28	52	Detent, Rear Sight	61755
B1-29	52	Spring, Rear Sight Detent	61754
B1-30	52	Screw, Rear Sight Windage	61702
B1-31	52	Sight, Rear	61700

APPENDIX B (CONT.)**REPLACEMENT PARTS LIST (CONT.)**

Figure No.	Page	Nomenclature	Part No.
		UPPER RECEIVER GROUP	
B1-32	52	Spring, Rear Sight	61708
B1-33	52	Pin, Roll, Forward Assist Assembly	95126
B1-34	52	Spring, Plunger	62271
B1-35	52	Pin, Roll (Pawl Pivot)**	95113
B1-36	52	Pawl, Forward Assist	62269
B1-37	52	Detent, Pawl	62270
B1-38	52	Spring, Detent, Forward Assist	50381
B1-39	52	Plunger Assembly	62266
B1-40	52	Receiver, Upper	62278
B1-41	52	Spring, Cover Latch	61696
B1-42	52	Latch, Cover	62321
B1-43	52	Ring, Retaining	62322
B1-44	52	Cap, Protective	91182

NOTE:

** = Multiple use item.

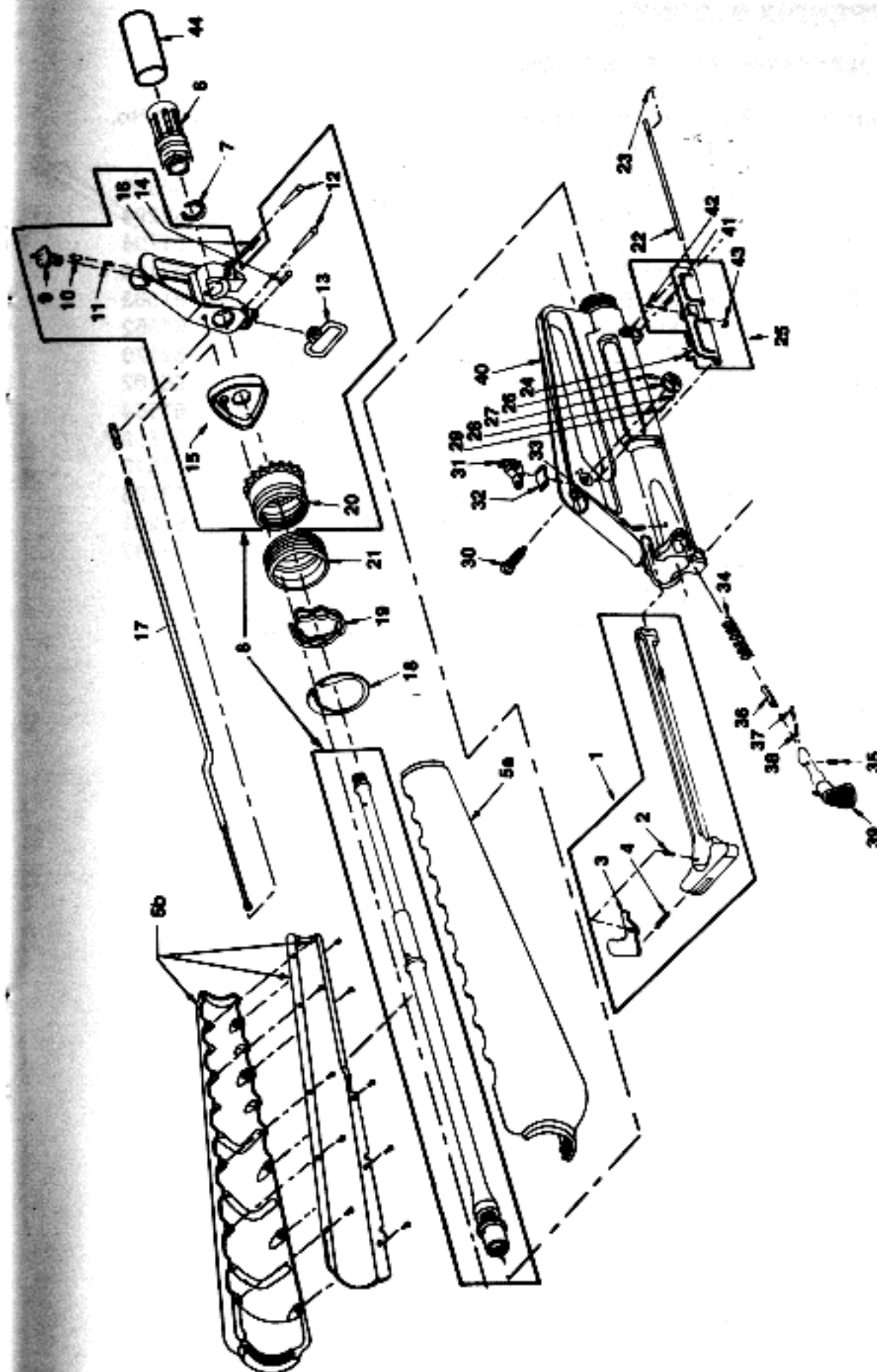

**FIGURE B-1. UPPER RECEIVER GROUP.
(SEE PAGES 50 & 51 FOR COMPONENT NOMENCLATURE)**

APPENDIX B (CONT.)**REPLACEMENT PARTS LIST (CONT.)**

Figure No.	Page	Nomenclature	Part No.
BOLT CARRIER GROUP			
B2-1	54	Pin, Retaining, Firing Pin	62335
B2-2	54	Pin, Firing	62294
B2-3	54	Pin, Cam	61704
B2-4	54	Bolt Assembly	62116
B2-5	54	Pin, Extractor	61563
B2-6	54	Extractor	61562
*B2-7	54	Spring, Extractor Assembly	62770
B2-8	54	Pin, Roll, Ejector	95102
B2-9	54	Ejector	61564
B2-10	54	Spring, Ejector and Safety Detent	61569**
B2-11	54	Ring, Bolt	61540
B2-12	54	Key & Bolt Carrier Assembly	62286
B2-13	54	Screw, Cap, Hex Socket Head	92201
B2-14	54	Key, Bolt Carrier	61547

*NOTE: P/N 62770 consists of P/N 62768, Insert Spring, and P/N 62769, Spring Extractor. Both parts must be used as a unit.

NOTE:

** = Multiple use item.

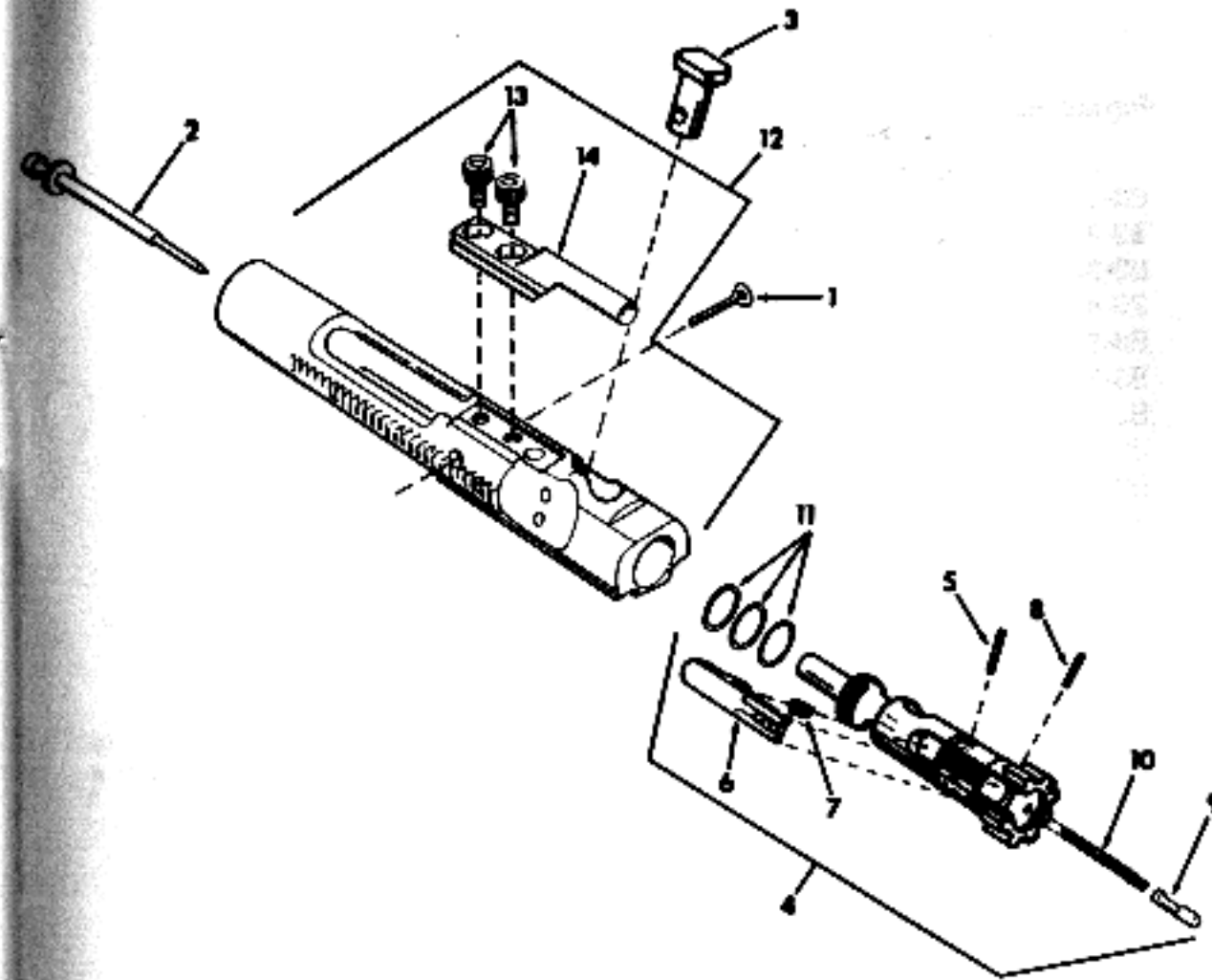

**FIGURE B-2. BOLT CARRIER GROUP
(SEE PAGE 53 FOR COMPONENT NOMENCLATURE)**

APPENDIX B (CONT.)**REPLACEMENT PARTS LIST**

Figure No.	Page	Nomenclature	Part No.
LOWER RECEIVER GROUP			
B3-1	56	Screw, Pistol Grip	92701
B3-2	56	Washer, Lock	90001
B3-3	56	Grip, Pistol	62194
B3-4	56	Spring, Ejector and Safety Detent	61569**
B3-5	56	Detent, Fire Control Selector	61785
B3-6	56	Spring, Detent, Takedown Pin	61692**
B3-7	56	Detent, Takedown Pin	61698**
B3-8	56	Pin, Takedown	61655
B3-9	56	Buffer Assembly	62339
B3-10	56	Spring, Action	61581
B3-11	56	Buttstock Stowage Assembly	62727
B3-12	56	Extension, Receiver	61574
B3-13	56	Screw Buttcap	92601
B3-14	56	'O' Ring Buttstock	90218
B3-15	56	Retainer, Buffer	61582
B3-16	56	Spring, Buffer Retainer	61694
B3-17	56	Pin, Hammer and Trigger	61654**
B3-18	56	Hammer & Hammer Pin Retaining Assembly	62317
B3-19	56	Spring, Hammer	61697
B3-20	56	Pin, Automatic Sear	61615
B3-21	56	Assembly, Automatic Sear	61622
B3-22	56	Selector, Fire Control	61959
B3-23	56	Disconnect	62334
B3-24	56	Trigger	61955
B3-25	56	Spring, Trigger	61657
B3-26	56	Spring, Disconnect	61925
B3-27	56	Pin, Roll, Bolt Catch	95105
B3-28	56	Catch, Bolt	62301
B3-29	56	Plunger, Bolt Catch	62178
B3-30	56	Spring, Bolt Catch	62177
B3-31	56	Catch, Magazine	61804
B3-32	56	Button, Magazine Release	62032
B3-33	56	Spring, Magazine Catch	61759
B3-34	56	Pin, Roll, Trigger Guard	95101**
B3-35	56	Trigger Guard Assembly	61970
B3-36	56	Pin, Receiver Pivot	62221
B3-37	56	Spring, Trigger Guard	61531
B3-38	56	Plunger, Trigger Guard	61250
B3-39	56	Bushing, Automatic Sear	61609

NOTE:

** = Multiple use item

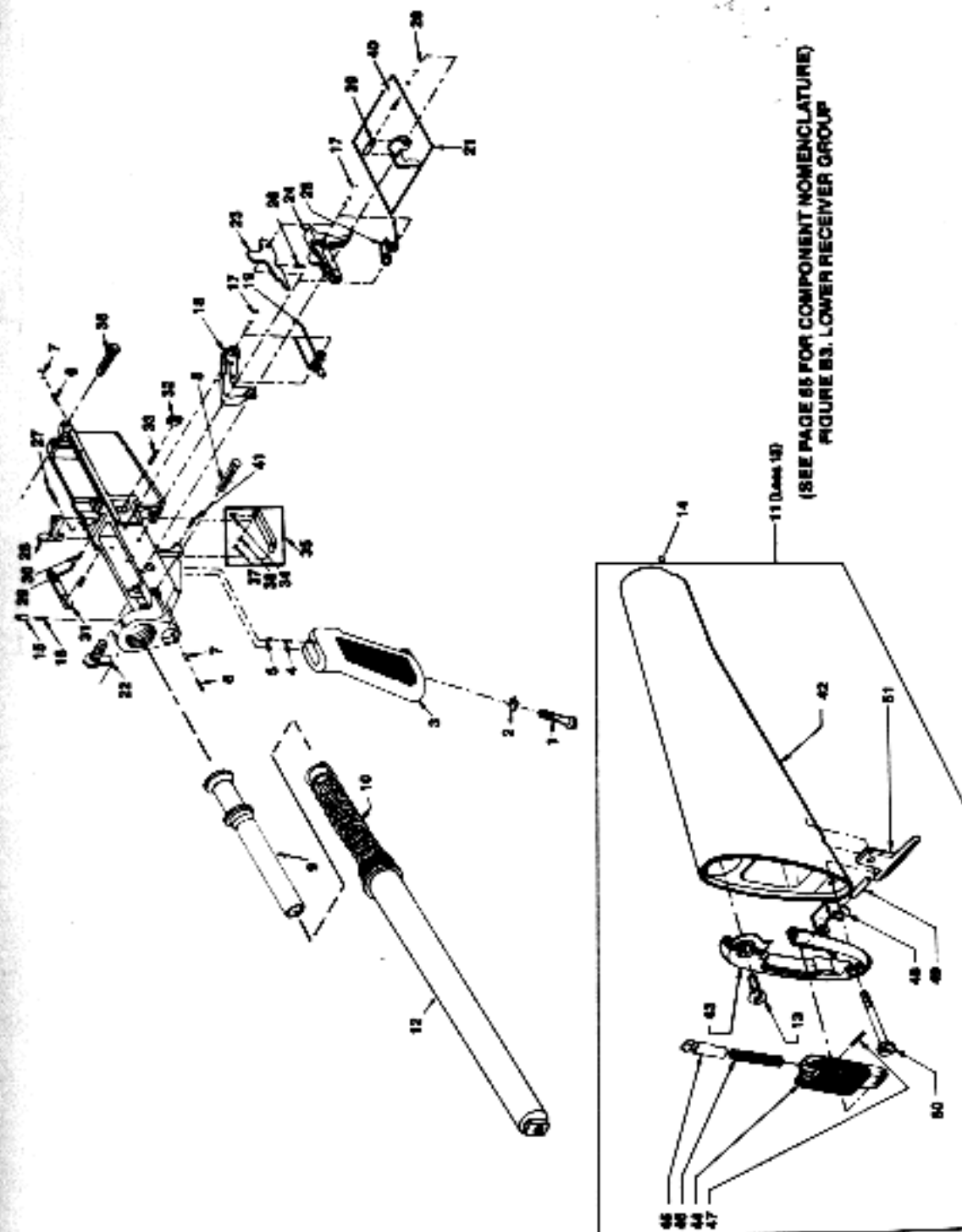

APPENDIX B (Cont.)**REPLACEMENT PARTS LIST**

Figure No.	Page	Nomenclature	Part No.
B3-40	56	Spring, Automatic Sear	61616
B3-41	56	Pin, Roll, Trigger Guard Pivot Pin	95106
B3-42	56	Buttstock	62738
B3-43	56	Buttplate Assembly	62728
B3-44	56	Door	62733
B3-45	56	Plunger	62731
B3-46	56	Spring, Plunger	62732
B3-47	56	Pin, Plunger Retainer	95201
B3-48	56	Hinge	62736
B3-49	56	Pin Hinge	62734
B3-50	56	Screw	62735
B3-51	56	Swivel	62737
B4-1	58	Sling, Silent	62249
B4-2	58	Loop, Sling Silent	62250
B4-3	58	Magazine Assembly—30 rounds	62328
B4-4	58	Follower, Magazine, Plastic—30 rounds	62665
B4-5	58	Spring, Magazine—30 rounds	62666
B4-6	58	Plate, Bottom, Magazine—30 rounds	62668

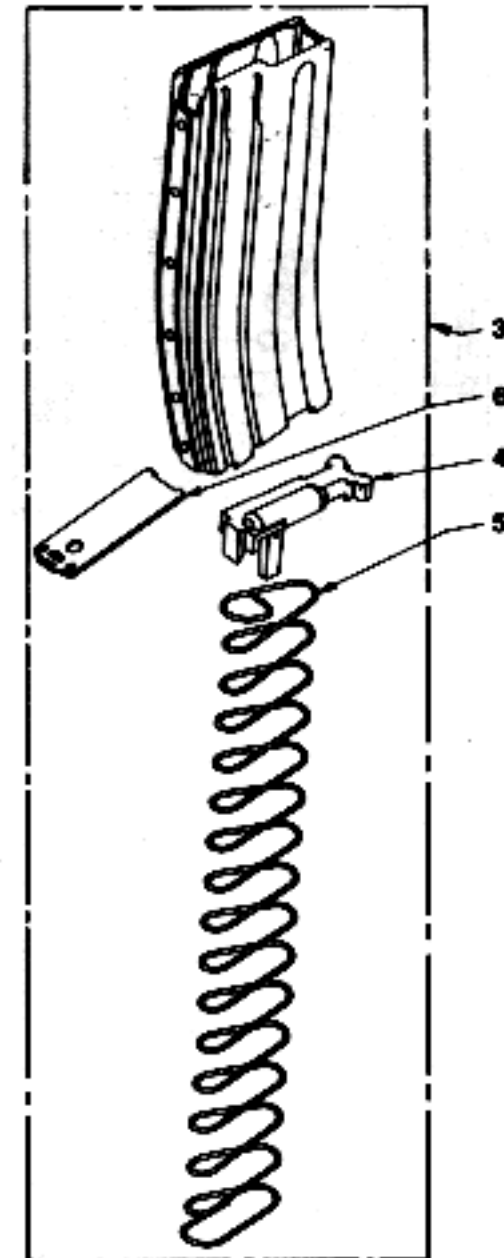

**FIGURE B4—SLING SILENT AND MAGAZINE
(SEE PAGE 57 FOR COMPONENT NOMENCLATURE)**

APPENDIX C

NUMERIC PARTS LIST

M16A1 RIFLE

Part No.	Part Name	No. Req'd.
50381	Spring, Detent, Forward Assist	1
61250	Plunger, Trigger Guard	1
61518	Spring, Ejection Port Cover	1
61531	Spring, Trigger Guard	1
61540	Ring, Bolt	3
61547	Key, Bolt Carrier	1
61562	Extractor	1
61563	Pin, Extractor	1
61564	Ejector	1
61569	Spring, Ejector and Safety Detent	2
61574	Extension, Receiver	1
61581	Spring, Action	1
61582	Retainer, Buffer	1
61601	Spring, Automatic Sear	1
61604	Catch, Magazine	1
61609	Bushing, Automatic Sear	1
61615	Pin, Automatic Sear	1
61616	Spring, Automatic Sear	1
61622	Assembly, Automatic Sear	1
61645	Gas Tube Assembly	1
61654	Pin, Hammer and Trigger	2
61655	Pin, Takedown	1
61657	Spring, Trigger	1
61658	Pin, Cover Hinge	1
61692	Spring, Detent Takedown Pin	2
61694	Spring, Buffer Retainer	1

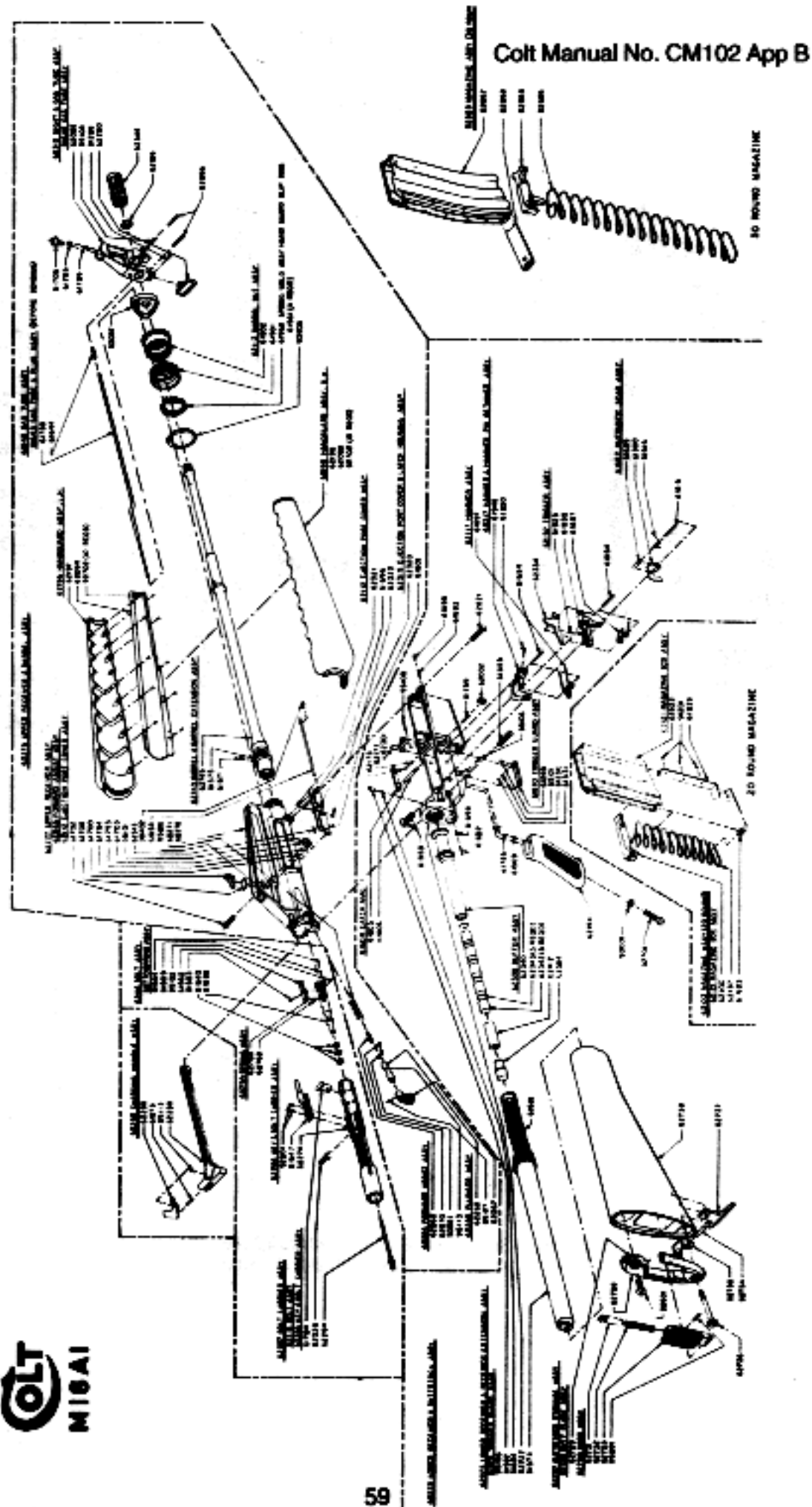

APPENDIX C (Cont.)**NUMERIC PARTS LIST (Cont.)****M16A1 RIFLE**

Part No.	Part Name	No. Req'd.
61696	Spring, Cover Latch	1
61697	Spring, Hammer	1
61698	Detent, Takedown Pin	2
61700	Sight, Rear	1
61702	Screw, Rear Sight Windage	1
61703	Drum, Windage	1
61704	Pin, Cam	1
61705	Detent, Front Sight	1
61706	Post, Front Sight	1
61708	Spring, Rear Sight	1
61709	Spring, Front Sight Detent	1
61754	Spring, Rear Sight Detent	1
61755	Detent, Rear Sight	1
61759	Spring, Magazine Catch	1
61785	Detent, Fire Control Selector	1
61875	Spring, Charging Handle Latch	1
61901	Slip Ring, Handguard	1
61902	Nut, Barrel	1
61925	Spring Disconnect	1
61955	Trigger	1
61959	Selector, Fire Control	1
61962	Spring Weld Assembly, Handguard Slip Ring	1
61970	Trigger Guard Assembly	1
62032	Button, Magazine Release	1
62086	Pin, Taper, Front Sight	2
62087	Cap, Handguard	1

APPENDIX C (Cont.)**NUMERIC PARTS LIST (Cont.)****M16A1 RIFLE**

Part No.	Part Name	No. Req'd.
62112	Ejection Port Cover Assembly	1
62116	Bolt Assembly	1
62126	Washer, Lock	1
62177	Spring, Bolt Catch	1
62178	Plunger, Bolt Catch	1
62194	Grip, Pistol	1
62198	Handguard Assembly LH	1
62198	Handguard Assembly RH	1
62221	Pin, Receiver Pivot	1
62249	Sling, Silent	1
62250	Loop, Sling Silent	As Required
62266	Plunger Assembly	1
62269	Pawl, Forward Assist	1
62270	Detent, Pawl	1
62271	Spring, Plunger	1
62278	Receiver, Upper	1
62280	Swivel, Sling	1
62286	Key & Bolt Carrier Assembly	1
62289	Latch, Charging Handle	1
62290	Charging Handle Assembly	1
62294	Pin, Firing	1

APPENDIX C (Cont.)**NUMERIC PARTS LIST (Cont.)****M16A1 RIFLE**

Part No.	Part Name	No. Req'd.
62301	Catch, Bolt	1
62317	Hammer and Hammer Pin Retainer Assembly	1
62321	Latch, Cover	1
62322	Ring, Retaining	1
62328	Magazine Assembly (30 Round)	1
62334	Disconnect	1
62335	Pin, Retaining, Firing Pin	1
62339	Buffer Assembly	1
62348	Suppressor, Flash	1
62665	Follower, Magazine, Plastic (30 Round)	1
62666	Spring, Magazine (30 Round)	1
62668	Plate, Bottom, Magazine (30 Round)	1
62727	Buttstock Stowage Assembly	1
62728	Buttplate Assembly	1
62731	Plunger	1
62732	Spring, Plunger	1
62733	Door	1
62734	Pin Hinge	1
62735	Screw	1
62736	Hinge	1
62737	Swivel	1
62738	Buttstock	1
62744	Replacement Barrel and Front Sight Assembly	1

APPENDIX C (Cont.)**NUMERIC PARTS LIST (Cont.)****M16A1 RIFLE**

Part No.	Part Name	No. Req'd.
62770	Spring Assembly, Extractor	1
90001	Washer, Lock	1
90402	Ring, Retaining, Ejection Port Cover	1
90403	Snap Ring, Handguard	1
91182	Cap, Protective	As Required
91209	Rivet, Front Swivel	1
92201	Screw, Cap, Hex Socket Head	2
92701	Screw, Pistol Grip	1
95101	Pin, Roll, Rear Sight, Drum and Trigger Guard	2
95102	Pin, Roll, Ejector and Plunger Retainer	1
95105	Pin, Roll, Bolt Catch	1
95106	Pin, Roll, Trigger Guard Pivot Pin	1
95108	Pin, Roll, Gas Tube	1
95113	Pin, Roll, Latch or Pawl Pivot	2
95128	Pin, Roll, Forward Assist Assembly	1

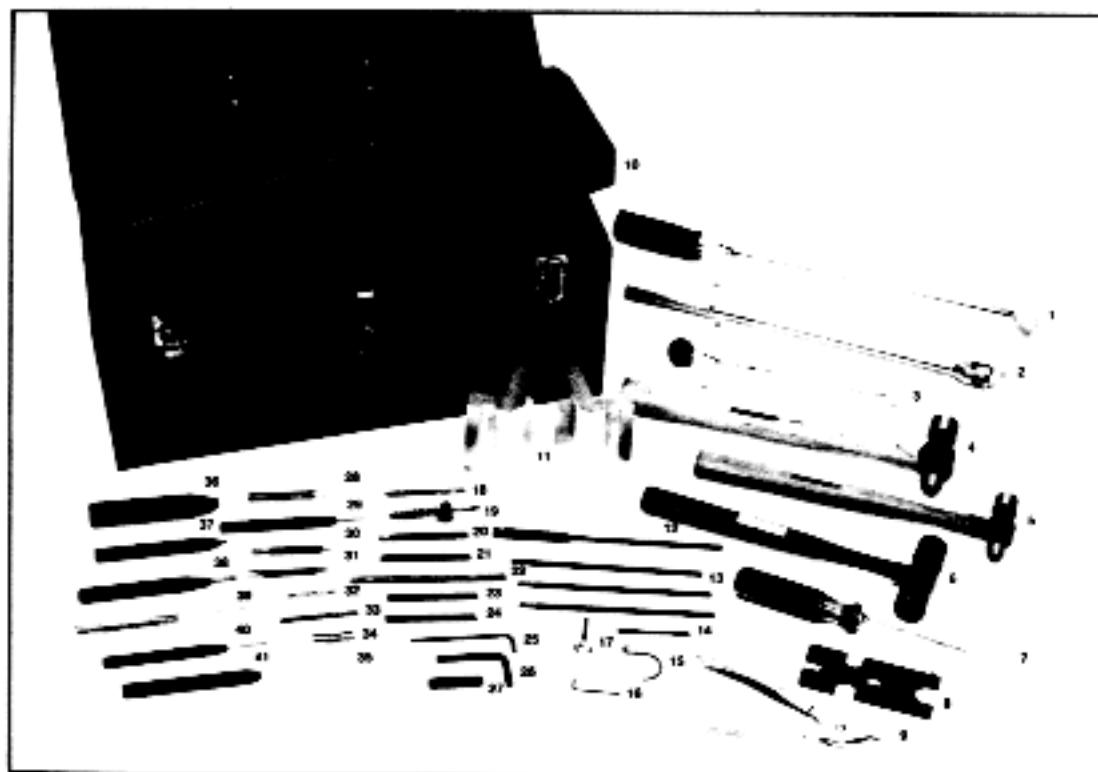

COLT'S ARMORER'S KIT CONTAINS THE NECESSARY TOOLS FOR INSPECTION, MAINTENANCE AND REPAIR OF THE M16 & M16A1 AUTOMATIC RIFLE. THE KIT IS INTENDED FOR USE BY THE ARMORER AND DEPOT PERSONNEL.

MAINTENANCE AND REPAIR ON THE MODEL M-3 BIPOD AND THE MODEL M-7 BAYONET CAN ALSO BE PERFORMED WITH THIS KIT.

Part No.	Description	Part No.	Description
1	94182 Wrench, Torque-Limiting, 1/2" Sq. Drive	23	62689 Setter, Punch, (.094 Dia. Pin)
2	94147 Handle, Wrench, Flexible	24	62688 Setter, Punch, (.078 Dia. Pin)
3	94181 Wrench, Torque-Limiting, 3/4" Sq. Drive	25	94180 Wrench, Hex Socket, Screw (Key, Socket Screw)
4	94149 Hammer, Ball Pein Machinist's 16 oz.	26	62686 Tool, Pivot Pin Detent Installation
5	94148 Hammer, Ball Pein Machinist's 8 oz.	27	62689 Wrench, Front Sight Adjusting
6	94150 Hammer, Soft Face, W/Plastic Tips	28	94154 Punch, Pin, Drive, (1/16 dia.)
7	94157 Screwdriver, Hand, Flat Blade, Mechanics	29	62687 Punch, Pin, Drive, (.075 dia.)
8	62686 Wrench, Combination	30	94152 Punch, Pin, Drive, (1/16 dia.)
9	94151 Pliers, Retaining Ring, External	31	62680 Punch, Pin, Bolt Catch Pivot
10	91414 Box, Tool, Steel	32	62679 Gage, Firing Pin Protrusion
11	62695 Vias Jawz, Barrel Removal	33	62683 Tool, Alignment, Barrel Nut
12	62704 Handle Assembly, Cleaning Rod, 5.56 MM	34	T-27921 Gage, Headspace (Field) (Colt)
13	62706 Rod Section, Cleaning 5.56 MM	35	62694 Tool, Reflector, Chamber
14	62687 Scrub Holder Section, Cleaning Rod 5.56 MM	36	62682 Punch, Pin, Starter, Taper Pin
15	62672 Depressor, Front Sight Detent	37	62689 Punch, Pin, Taper, Insertion
16	62673 Depressor, Pivot Pin Detent	38	94146 Punch, Center
17	94158 Socket, Wrench, Hex Bit, W/Short Bit	39	94156 Punch, Pin, Drive, (1/16 dia.)
18	94144 Brush, Cleaning, Bore 5.56 MM	40	94155 Punch, Pin, Drive, (1/16 dia.)
19	94145 Brush, Chamber Cleaning	41	62715 Tool, Swaging Rivet
20	62682 Setter, Punch (W/Flat)		
21	62681 Setter, Punch, (.125 Dia. Pin)		
22	62680 Setter, Punch, (.094 Dia. Pin)		